

REGIONAL DISTRICT OF NANAIMO
BYLAW NO. 500.388

A Bylaw to Amend Regional District of Nanaimo
Land Use and Subdivision Bylaw No. 500, 1987

The Board of the Regional District of Nanaimo, in open meeting assembled, enacts as follows:

- A. This Bylaw may be cited as "Regional District of Nanaimo Land Use and Subdivision Amendment Bylaw No. 500.388, 20__".
- B. "Regional District of Nanaimo Land Use and Subdivision Bylaw No. 500, 1987", is hereby amended as follows:
 1. By adding Schedule 4D1 – Lakes District and Schooner Cove Community Sewer System Standards as shown on Schedule '1' which is attached to and forms part of this Bylaw.
 2. By adding Schedule 4C1 – Lakes District and Schooner Cove Community Water System Standards as shown on Schedule '2' which is attached to and forms part of this Bylaw.
 3. Under **PART 4 SUBDIVISION REGULATIONS, Section 4.7 Sewage Disposal** by adding the following after Section 4.7 (2):
 - 3) Notwithstanding Section 4.7 (2), for lands within the Lakes District and Schooner Cove Community Water and Sewer Standards Area any community sewer system, or part thereof, provided within the subdivision, to service the subdivision or to connect the sewage collection system within the subdivision to a Regional District trunk sewage main shall, if constructed after the enactment of this Bylaw, be constructed and installed at the expense of the owner of the land being subdivided and shall be carried out in accordance with the standards and specifications set out in Schedule '4D1'.
 4. Under **PART 4 SUBDIVISION REGULATIONS, Section 4.8 Water Supply** by inserting the following after Section 4.8 (2) and renumbering subsequent sections accordingly:
 - 3) Notwithstanding Section 4.8 (2), for lands within the Lakes District and Schooner Cove Community Water and Sewer Standards Area any community water system, or part thereof, provided within the subdivision, to service the subdivision or to connect the water distribution system within the subdivision to a Regional District trunk water main shall, if constructed after the enactment of this Bylaw, be constructed and installed at the expense of the owner of the land being subdivided and shall be carried out in accordance with the standards and specifications set out in Schedule '4C1'.
 5. The Lakes District Lakes District and Schooner Cove Community Water System Standards and the Lakes District and Schooner Cove Community Sewer System Standards will apply to lands within the Lakes District and Schooner Cove Water and Sewer Standards Area as shown on the attached Schedule '3' and legally described as

- a. Lot 1, District Lots 30 and 78, Nanoose District, Plan 26219, except those parts in Plans 28246, 29574, 30072, 30262, 34675, 36514, 48548 and VIP53001;
- b. Lot 8, District Lot 78, Nanoose District, Plan 30262;
- c. District Lot 11, Nanoose District, Except that part outlined in red on Plan 1567 OS, 48548 and VIP59496;
- d. District Lot 7, Nanoose District, Except that part outlined in red on Plan 1567 OS, 48548, VIP59496 and VIP80856;
- e. District Lot 30, Nanoose District, Except those parts in Plans 15193, 26219, 48585, VIP51706, VIP51707, VIP52451, VIP53134, VIP57407, VIP60049, VIP60602 and VIP88308; and,
- f. District Lot 78, Nanoose District, Except that part shown outlined in red on Plan deposited under DD 19579I; Except Parcels A and B (DD 7528N); and Except those parts in Plans 813R, 1567 OS, 14212, 14250, 14275, 15075, 15193, 22836, 24012, 25366, 26219, 27129, 27206, 29869, 34675, 47638, 48548, 48585, 49669, 50872, 51142, VIP51603, VIP51706, VIP51707, VIP53134, VIP57407, VIP59180, VIP59494, VIP60049, VIP60602, VIP71781, VIP73214, VIP78139, VIP80854, VIP80855, VIP80856, VIP85588 and VIP88308.
- g. Lot 1, District Lot 78, Nanoose District, Plan 28544;
- h. Lot 1, District Lot 78, Nanoose District and District Lots 2085, 2086, 2087, 2088 and 2089 Nanaimo District Plan VIP87121; and,
- i. Lot 1, District Lot 2090 Nanaimo District and District Lot 78 Nanoose District Plan VIP87122.

Introduced and read two times this ___ day of _____ 20__.

Public Hearing held this ___ day of _____ 20__.

Read a third time this ___ day of _____ 20__.

Adopted this ___ day of _____ 20__.

Chairperson

Corporate Officer

Schedule '1' to accompany "Regional District of Nanaimo Land Use and Subdivision Amendment Bylaw No. 500.388,20__"

Chairperson

Corporate Officer

Schedule '1'

Schedule 4D1

Lakes District and Schooner Cove Community Sewer System Standards

**REGIONAL DISTRICT OF NANAIMO
AMMENDMENTS FOR LAKES DISTRICT AND SCHOONER COVE PDA
COMMUNITY WATER SYSTEM STANDARDS**

GENERAL

The water standards for design and construction for the Lakes and Schooner Cove areas are to be governed by the 2013 RDN Bylaw 500 –Community Water System Standards as modified by these supplemental specifications. All modifications contained in this document overrule the original document.

The physical and temporal limits of this document are as outlined in the RDN/bcIMC Phased Development Agreement (PDA).

Subsequent modifications to the RDN's bylaw 500 will not apply to the PDA lands unless both parties agree in writing to modify them.

MODIFICATIONS TO CLAUSES IN BYLAW 500

Section 1.1 Requirement

The PDA will replace the "Subdivision Servicing Agreement"

Section 1.11 WallBrook Groundwater Well Approval Process

The process for applications involving the phased addition of each of the groundwater wells at the WallBrook site (2 sites located on Northwest Bay Road and legally described as PCL. C, DD 36525-N; and PT. D.L. 22, Plan 445R), shall be as follows:

- a) The applicant submits a Feasibility Review application per Section 1.4(1) above and in accordance with the Board Policy B1.21 and including: VIHA source approval letter; and Hydrology Report required per Section 2.6.1 above. The Hydrogeology Report shall rate the capacity of the proposed new well and all other wells in the WallBrook wellfield that have been dedicated to date by the Applicant, with the incremental or new capacity being ascribed to the proposed new community water wellfield. It is recognized that this will implicitly account for interference between wells.
- b) The RDN will reply in a timely manner (per Section 1.4(1) indicating either:
 - acceptance, in which case clarification shall be provided whether any optional provisions set out in the VIHA source approval letter are required by the RDN; or
 - resubmission required, in which case the letter shall set out how the application is not in compliance with the standards set out herein, and the Applicant may resubmit per subsection (a).
- c) The Applicant may then submit a Detailed Design application per Section 1.4(2) above.
- d) RDN to reply in a timely manner indicating, indicating either:
 - acceptance; or

- resubmission required, in which case the letter shall set out how the application is not in compliance with the standards set out herein.
- e) Upon completion of the construction of well infrastructure required per subsection (d) above, the parties shall arrange to connect the new well to the Community Water System, at which point:
- the well and related improvements shall become property of the RDN; and
 - DCC credits applicable to the Applicant's expenditures shall be provided.
- f) Water capacity attributable to the dedication a new well shall be recognized in the following increments:
- i) concurrent with completion and connection under subsection (e) above, a "Preliminary Capacity Rating" of the new incremental capacity of the wellfield concluded under the Feasibility Review (subsection (a) above) shall be made available firstly for the satisfaction of water requirements relating to any subdivision application(s) submitted by the Applicant prior to the connection of such well, and then generally for the use of the community water system; and
 - ii) a "Final Well Capacity Rating" shall be determined based on the results of a Hydrogeology report per subsection (a) above, and in accordance with RDN Board Policy b1.21, If and to the extent that the Final Well Capacity Rating is greater than the aggregate of the Preliminary Well Capacity Rating(s) ascribed to each of the WallBrook wells previously dedicated by the Applicant, such additional capacity in igpm shall be made available firstly to satisfy water requirements for any subdivision application(s) previously submitted by the Applicant, and then to the community water system generally. The RDN agrees to operate the wellfield as per the instructions of the hydrogeologist such that the well can be properly tested over one dry season.
- h) It is recognized that the RDN will own, control and operate the wells prior to the Final Well Capacity Rating, and shall therefore have sufficient opportunities to expose the wells to the demands required for testing, subject to the conditions to RDN's operation of community water wells in the wellfield prior to the Final Well Capacity Rating, as follows:

Section 2.5 Water Quality

This section is amended by requiring that deviations from this specification not only require board approval but also require written agreement from Fairwinds unless mandated by authorities with jurisdiction over their operation.

2.6 Supply Sources

1. Groundwater Source

The sixth paragraph stated as follows:

'The well completion report shall record results of well pumping tests which shall only occur during the late summer or early fall (August, September,

October as this time is generally the lowest ground water levels of the year), and contain conclusions as to the capability of the source with a 30% percent drawdown safety factor under conditions of zero surface recharge for 120 days (this figure may be reduced 100 days if authorized in writing by the RDN). All interference effects from adjacent constructed wells, on the assumption that they are all fully operational on a continuous basis over the same 120 day period, shall be allowed for in addition to the 30% drawdown safety factor. No safety factor is required to be added to the interference drawdown allowance. The Design Professional shall recommend a rated pumping capacity for the well which will be reviewed by the RDN and possibly agreed to; the RDN does have the discretion to de-rate the well pumping capacity further if in its opinion the aquifer is susceptible to decreasing ground water tables or historical well information from the area shows wells to decrease in capacity over time.'

Shall be modified to remove the extra de-rating mentioned above since the wells are to be measured later. The new section will read as follows:

'The well completion report shall record results of well pumping tests which shall only occur during the late summer or early fall (August, September, October as this time is generally the lowest ground water levels of the year), and contain conclusions as to the capability of the source with the standard MOE 30% percent drawdown safety factor under conditions of zero surface recharge for 120 days (this figure may be reduced 100 days if authorized in writing by the RDN). All interference effects from adjacent constructed wells, on the assumption that they are all fully operational on a continuous basis over the same 120 day period, shall be allowed for in addition to the 30% drawdown safety factor required by MOE. No safety factor is required to be added to the interference drawdown allowance. The Design Professional shall recommend a rated pumping capacity for the well which will be reviewed by the RDN and As per 1.11 f ii) the wells will be subject to a re-rating by the hydrogeologist and may be re-rated under the hydrogeologists direction.

REGIONAL DISTRICT OF NANAIMO
BYLAW NO. 500
SCHEDULE '7D'
COMMUNITY WATER SYSTEM STANDARDS

REGIONAL DISTRICT OF NANAIMO

BYLAW NO. 500

COMMUNITY WATER SYSTEM STANDARDS
TABLE OF CONTENTS

1.	GENERAL	1
1.1	Requirement.....	1
1.2	Design.....	1
1.3	Definitions.....	1
1.4	Application.....	1
1.5	Drawings and Specifications.....	2
1.6	Variations from Standards.....	3
1.7	Permits.....	4
1.8	New Service Areas.....	4
1.9	Existing Service Areas.....	4
1.10	Inspection.....	4
2.	DESIGN	4
2.1	Water Demand.....	4
2.2	Water Pressure.....	65
2.3	Design Population.....	65
2.4	Hydraulic Network.....	6
2.5	Water Quality.....	6
2.6	Supply Sources.....	76
2.7	Storage.....	11
2.8	Water Distribution Piping.....	1342
2.9	Service Connections.....	1443
2.10	Fire Hydrants.....	1544
2.11	Valves.....	15
2.12	Fittings.....	1746
2.13	Trenching and Backfill.....	1746
2.14	Pressure Reducing Stations.....	18
2.15	Booster Pump Stations.....	1948
2.16	Water Meter Chambers.....	2049
3.	CONSTRUCTION	2120
3.1	General.....	2120
3.2	Existing Structures and Utility Works.....	2224
3.3	Clearing.....	2423
3.4	Trench Alignment and Depth.....	2423

3.5	Pipe Installation	24
3.6	Trench Backfill	<u>2524</u>
3.7	Repairs	<u>2524</u>
4.	<i>TESTING AND DISINFECTION</i>	<u>2524</u>
4.1	Written Reports	<u>2524</u>
4.2	Leakage Tests	<u>2524</u>
4.3	Flushing	<u>2625</u>
4.4	Chlorination	<u>2625</u>
4.5	Inspection	<u>2625</u>
5.	<i>TRANSFERRING THE WATER SYSTEM TO THE RDN</i>	<u>2726</u>
5.1	Final Inspection by RDN	<u>2726</u>
5.2	Preparation/Execution of Transfer Agreement by Developer	<u>2726</u>
5.3	Preparation/Execution of Maintenance Agreement	<u>2726</u>
5.4	Preparation/Execution of Latecomer Agreement	<u>2827</u>
5.5	Letter of Acceptance of the Works by RDN	<u>2827</u>

APPENDICES

Appendix 1	Subdivision Servicing Agreement
Appendix 2	Standard Drawings
Appendix 3	Approved Products List
Appendix 4	Letter of Assurance
Appendix 5	Certificate of Design
Appendix 6	Certification of Installed Works
Appendix 7	Fire Hydrant Use Permit
Appendix 8	Hydrant Certification Form
Appendix 9	Transfer Agreement
Appendix 10	Maintenance Agreement
Appendix 11	Outline for Wellhead Protection Report
Appendix 12	Standby Irrevocable Letter of Credit
Appendix 13	Latecomer Agreement

1. GENERAL

1.1 Requirement

The RDN will require a “**Subdivision Service Agreement**” to be completed for any new water system or existing system extension, unless otherwise agreed to in writing by the RDN.

Water supply and distribution systems shall be designed, installed, extended, tested and maintained in accordance with the following standards and specifications.

1.2 Design

The engineering design of the water system shall be carried out by, and the preparation of drawings and specifications shall be sealed by a Professional Civil Engineer registered in the Province of British Columbia (**the Design Professional**), and shall conform to these Standards.

1.3 Definitions

Engineer

The Manager of Engineering Services for the Regional District of Nanaimo, or the person designated by the General Manager of Regional and Community Utilities.

Engineer of Record

A Professional Engineer registered with the Association of Professional Engineers and Geoscientists of BC who is responsible for the construction drawings and documents. The Engineer of Record will be the engineer that signs and seals the record drawings and Certification of Installed Works.

Facilities

Water lines, water treatment plants, pumping stations and other works necessary thereto, and for carrying potable water and includes any and all works, structures, lands, conveniences, incidental to and necessary for a water system.

Member Municipality or Member

A municipality or improvement district within the Regional District of Nanaimo.

Regional District

In the document the Regional District shall refer to the Regional District of Nanaimo.

1.4 Application

All applications shall be made in two steps as follows:

1. **Feasibility Review**

All proposed construction of water supply and distribution facilities shall be submitted to the Regional District for a feasibility review prior to commencement of any detailed design or construction. Such requests shall

include a plan of the proposed construction and the area it will serve. The applicable feasibility review fee, in accordance with RDN Bylaw No. 1259.03 or most recent amendment, and the **Letter of Assurance** shall also be submitted at this time.

The Regional District will review the proposal, and reply in writing indicating approval or listing the necessary amendments required.

To be addressed but not limited to, are the following items:

- (a) source of water
- (b) initial plan of the works showing equipment/pipe sizes, materials etc.
- (c) number of properties and population served
- (d) alignments/offsets of pipes etc.
- (e) any flow and/or pressure concerns

2. Detailed Design

The detailed design and specifications shall be submitted in duplicate to the Regional District for Design Stage Approval (DSA) prior to construction and is valid for up to 180 days from the date of issue. Attached to the submission shall be a **Certificate of Design**. The applicable engineering review fee, in accordance with RDN Bylaw No. 1259.03 or most recent amendment, shall also be submitted at this time, along with the Design Professional's certified cost estimate for the works upon which the fee amount is based. *The final determination of the DSA fee shall be determined upon completion of the project and final certification of the construction costs by the **Design Professional**.*

The detailed plans will be returned either approved or with a request for re-submission. Re-submission will be carried out until the Regional District approves the detailed plans and specifications, and issues Design Stage Approval (DSA).

The Design Professional shall submit the RDN approved plans to the Provincial Ministry of Transportation & Infrastructure and Vancouver Island Health Authority for any approval permits that may be required. Receipt and submission of these permits to the RDN shall also be a prerequisite to the start of construction. Approval permits from other applicable agencies as required shall also be obtained.

1.5 Drawings and Specifications

All design drawings shall be ISO A1 size, 594 mm in depth and 841 mm in width. The following information shall be supplied:

1. **Location Plan** - showing the location of the proposed work. This may appear on the same sheet as the Key Plan.
2. **Key Plan** - showing a plan of the proposed work at a suitable scale such that the whole works are shown on one drawing, usually 1:5000, 1:2000 or 1:1000. The Key Plan shall show a general outline of the works, area covered

and sheet numbers of the plan/profile drawings, and a legend showing existing and proposed works.

3. **Plans/Profiles** - showing detailed design of the proposed works. Profiles of mains 200 mm in size and under are not required unless otherwise specified by the Regional District.

Plans shall be drawn at a scale of 1:500 (1:250 is also acceptable), showing the location of the pipe centreline, pipe size and type and off-set from property line, hydrants, valves, fittings and all related appurtenances in relation to road, easement and adjacent property and lot lines. Existing or proposed underground utilities are to be indicated on the plan in addition to the extent of work required in making connection to existing water main. Location of service connections are to be shown. Connections not conforming to the standard offset require a distance from an iron pin or lot line. In general, water services shall be installed two in a trench at property corners, 1200 mm from the lot line, and alternate with hydro and telephone poles.

Profiles shall be drawn at a horizontal scale of 1:500 and a vertical scale of 1:50 if more suited to specific conditions. The profile shall show the line of the existing and finished road grade on centreline, the invert of the pipe, location of fittings and hydrants, and location of sanitary and storm utilities. Where the pipe is not to be laid at a constant depth below the finished grade, the invert elevation shall be shown at pipe deflections and vertical bends.

Drawings detailing plans and elevations shall be prepared for wells and wellheads, supply intake works, pump stations, major valve chambers, and storage reservoirs. Suitable standard scales shall be chosen, being either 1:50, 1:20, 1:10, or 1:5.

4. **Specifications** - shall be prepared to further define materials of construction and shall specify methods of construction and workmanship.
5. **Record Drawings** - shall be prepared by correcting drawings on completion of construction in order to reflect "as-built" conditions for permanent records. The location of all individual lot water service connections shall be clearly shown. The drawings shall be signed and sealed by the Professional Civil Engineer, and shall be accompanied by a Certification of Installed Works. Final record drawings shall consist of:
 - a) 2 full-size paper sets;
 - b) one full size 3 mil Mylar set;
 - c) 2 – 11" X 17" paper sets or 2 A3 half-size paper sets, as agreed by the RDN; and
 - d) digital copies, one as AutoCAD or Civil 3D file as applicable to the current software, and one as TIFF files.

1.6 Variations from Standards

Where the applicant wishes to vary from these standards he shall submit a written request with adequate supporting data to the Regional District for review.

The Regional District shall make the final decision in writing as to the standard requirements which shall apply.

1.7 Permits

The applicant shall be responsible for obtaining all necessary approvals and permits required prior to commencing construction of the water system.

1.8 New Service Areas

Where a water system is to be constructed by an applicant within an area previously unserved by a community water system, the design and construction for the system shall comply with the requirements of these Standards, unless otherwise agreed to in writing by the Regional District.

1.9 Existing Service Areas

Where a water system is to be constructed by an applicant within the existing or extended boundaries of an area already being served by a community water system, the design and construction of the system shall comply with the requirements of these Standards, with the understanding that Sections 2.5 and 2.6 may not apply and will be determined by the RDN according to the project and available existing source capacity and water quality.

1.10 Inspection

The Manager of Engineering Services of the Regional District or his appointed deputies shall be allowed access and provided adequate facilities for access to any part of the works at all times for the purpose of inspection.

Any connections to or interruption of any existing system will be under the direct supervision of the Regional District. Adequate notice to the Regional District of any such interruption to service shall be provided in order that attendance by Regional District personnel can be arranged.

The design engineer appointed by the Developer/Owner shall be employed during construction of the works to confirm the project is/has been constructed according to the design drawings and specifications. At the end of the project the engineer shall provide a Certification of Installed Works indicating the works were constructed according to the plans and specifications and meet all applicable codes / regulations / bylaws.

2. DESIGN

2.1 Water Demand

Water sources and primary supply mains shall be designed to supply the maximum day's demand, while distribution mains and booster pump stations must be sized to handle the peak hourly or fire flows. The volume of water in storage acts as a cushion between these differing flows.

The water distribution system shall be designed according to the following minimum demands:

1. Residential

Replacement Section 2.1.1 Water Demand - Residential

Housing Unit	Max Litres per Day per Person	Max Imperial Gallons per Day per Person	Persons Per Household	IGPM per Housing Unit
		(A)	(B)	(A/24/60XB)
Single-Family/detached house	1,168	250	2.2	0.38
Townhouse (attached, semi-detached) unit	914	200	1.9	0.26
Apartment / condominium unit	424	90	1.4	0.09
Secondary suite (carriage house)	424	90	1.1	0.07
Seniors Living unit	424	90	1.1	0.07

2. Commercial and Industrial

Water demands for developments involving commercial or industrial zoned lands shall be in accordance with good engineering practice as determined by the Design Professional and approved in writing by the Regional District.

Replacement Section 2.1.2 Water Demand - Commercial

Non-residential uses			
Commercial – Retail	480	105	Per 1000 sf leasable
Commercial – Office	640	140	Per 1000 sf leasable
Commercial – Restaurant	3500	770	Per 1000 sf leasable
Commercial – Pub	3500	770	Per 1000 sf leasable
Fitness Centre	490	105	Per 1000 sf leasable

3. Fire

Required fire flows shall be in accordance with the "Water Supply for Public Fire Protection - A Guide to Recommended Practice" as published by Public Fire Protection Survey Services, but in no case shall be less than 4.55 m³/min (1000 igpm) for 90 minutes unless approved in writing by the Regional District.

2.2 Water Pressure

Minimum design distribution pressure in all areas at peak demand shall be 276 kPa (40 psi) at the property line. The design engineer shall indicate any building sites where the pressure at the main floor of the building is expected to be less than 207 kPa (30 psi). The developer is expected to file covenants of low pressure on properties where the pressure at the main floor of the building is expected to be less than 207 kPa. With the combination of maximum daily demand and the specified fire flow, the minimum residual water pressure at the fire hydrant shall be 138 kPa (20 psi), and at the highest point in the system shall not fall below 69 kPa (10 psi). Where these minimum design pressures cannot be maintained due to an increase in elevation or distance from the point of connection, a booster pump station and emergency storage shall be provided as part of the distribution system.

The maximum allowable distribution line pressure is 900 kPa (130.5 psi) except where individual connections are permitted directly from trunk mains and where special precautions are taken. Otherwise, where distribution pressures will exceed 900 kPa due to a drop in elevation, a pressure reducing station shall be installed as part of the distribution system. Where distribution pressures exceed 550 kPa (80 psi), occupants in the area shall be required to install individual pressure reducing valves. This valve shall be of an approved design and manufacture.

2.3 Design Population

Design populations used in calculating water demand for residential properties shall be computed in accordance with the population predictions based on the total number of residential units and persons per unit (ppu) as determined by the Regional District from census data or with the persons/hectare (in 2011 an average single family detached home has 2.2 ppu*) :

Multiple dwelling unit development	125 persons/hectare
Dwelling unit	30 persons/hectare (12.5 homes/hectare)

Exceptions to these design population densities may be varied by the Regional District of Nanaimo with Board Approval.

2.4 Hydraulic Network

Depending on the complexity and extent of the proposed distribution system, the Regional District may require a hydraulic network analysis showing maximum design flows and minimum design pressures. If this information is required, it will be stated by the RDN in writing at the time of the **Feasibility Review** and shall be submitted by the applicant with the detailed design application. The hydraulic network shall be designed to provide the maximum design flows at or above the minimum required pressures specified in this Standard.

2.5 Water Quality

1. Water supplied to domestic consumers shall be of a quality meeting the guidelines for microbiological, chemical, and physical parameters listed in the

“latest edition” of the Guidelines for Canadian Drinking Water Quality prepared by the Federal-Provincial-Territorial Subcommittee on Drinking Water. All new water source quality shall have parameters equal to or less than the aesthetic objectives (AO) listed in these guidelines. If necessary, treatment of the source water to reduce iron and manganese below AO shall be provided. Exceptions to these parameters may be approved in writing by the Regional District of Nanaimo with Board Approval.

2. All surface water supplies shall be suitably treated and disinfected as per provincial requirements/regulations. Disinfection will normally be solely by chlorination using proportional solution feed, but other approved methods will be considered, including ultraviolet (UV) units, provided residual chlorination is included.
3. Groundwater sources may require chlorination, either at the discretion of the Vancouver Island Health Authority (VIHA), or by the RDN to suit operational requirements such as integrating a new source into an existing chlorinated system. Space shall, as a minimum, be provided for all chlorine storage and associated equipment.

2.6 Supply Sources

1. Groundwater Source

Where groundwater is to be the source of supply, a copy of the well driller's log shall be submitted, together with a copy of a well completion report by a Design Professional or a professional geoscientist registered in the Province of British Columbia (The Design Professional). All new wells shall be constructed in accordance with the Groundwater Protection Regulations, November 1, 2005, or their most recent amendment or replacement legislation.

Wells shall be cased with a minimum 200 mm (8 inch) diameter steel casing having a minimum stickup of 300 mm (12 inches) above the proposed final ground surface. The well shall be completed with stainless steel screen(s) selected following sieve analysis of aquifer material, and shall have a surface casing of a minimum 250 mm (10 inch) diameter surrounding the 200 mm well casing (unless otherwise approved in writing by the RDN). The length of the surface casing shall be designed by The Design Professional and shall not be less than 3 meters (10 feet). A surface seal of at least 4.5 meters (15 feet) shall be installed as per the standard contained in the BC Ground Water Protection Regulation. The ground surface around the well head shall be graded to slope away from the well head at 2% grade or greater.

Any wells which encounter bedrock and source water from within rock, shall have well casing driven into the rock to establish a seal and have a surface annular seal placed to the depth at which bedrock is encountered or to a minimum depth of 4.5 meters (15 feet), whichever is less. All wells completed in bedrock must be equipped with PVC liner with threaded joints to allow for removal of the PVC for periodic well maintenance.

Modifications to well casing to allow for shallow subsurface connection, i.e., pitless adapter units, will require that the surface annular seal be re-established. All new wells shall be equipped with a 25 mm (1 inch) diameter

PVC monitoring tube for the installation of a standard water level measuring device without danger of being stuck in the well.

The new well shall have a Well Identification Plate as issued by the BC Ministry of Environment attached to the well casing exposed at surface and clearly visible. Copies of all information for the well including the drillers log, pumping test data, analysis and written reports shall be submitted to the BC Ministry of Environment, VIHA and RDN.

The well completion report shall record results of well pumping tests which shall only occur during the late summer or early fall (August, September, October as this time is generally the lowest ground water levels of the year), and contain conclusions as to the capability of the source with a 30% percent drawdown safety factor under conditions of zero surface recharge for 120 days (this figure may be reduced 100 days if authorized in writing by the RDN). All interference effects from adjacent constructed wells, on the assumption that they are all fully operational on a continuous basis over the same 120 day period, shall be allowed for in addition to the 30% drawdown safety factor. No safety factor is required to be added to the interference drawdown allowance. The Design Professional shall recommend a rated pumping capacity for the well which will be reviewed by the RDN and possibly agreed to; the RDN does have the discretion to de-rate the well pumping capacity further if in its opinion the aquifer is susceptible to decreasing ground water tables or historical well information from the area shows wells to decrease in capacity over time.

The Design Professional shall also assess if and what interference effects the new well will have on any adjacent operating RDN system wells. He shall provide an assessment of the effect in total litres per second of capacity reduction which those operating wells are anticipated to have over the 120 day zero surface recharge condition with the new well operating. The new well pump will be required to be sized to the full long term design capacity, but the allowable new supply applicable to support new development will be lowered by any such capacity reduction which it may have on operating RDN wells.

The well pumping test shall be run for 48 hours continuous pumping (72 hours in bedrock wells) at a pumping rate at or above the projected long-term pumping capacity of the well or until the water level stabilizes, whichever is the longest time. Adjacent constructed wells shall be monitored during the test pumping period, to allow The Design Professional to assess interference effects. Well recovery measurements shall also be carried out immediately on completion of the test pumping period and shall continue until the well has recovered to at least 95% of its initial level (the RDN may reduce this recovery to 80% but this must be authorized in writing by the RDN). A minimum long-term well design capacity rating of 3.8 l/s (50 igpm) is required for any individual well. The minimum standards for pumping test and well capacity can only be altered in writing by the RDN, where under special circumstances wells meeting all quality guidelines and a capacity rating between 2.3 l/s and 3.8 l/s may be considered by the RDN for acceptance. Well testing procedures shall be in accordance with information provided by the BC Government. In no case shall the pumping test be of less time than it takes to produce a relatively stable water level in the well for an adequate period of time, as approved by The Design Professional.

The well completion report shall include a water balance for the aquifer, which accounts for seasonal recharge and withdrawals by users both directly up-gradient and down-gradient of the existing and proposed subdivision lots. All assumptions incorporated into the water balance calculations shall be stated in the report. The well completion report shall also include an assessment of any risk of flooding around the well and indicate what measures have been taken or will be taken to protect the well or wellhead from entry of flood debris or flood waters or physical damage due to flood debris, ice or erosion. Flood proofing shall be in accordance with the Drinking Water Protection regulation, Section 14 and the Ground Water Protection Regulation, Section 11.

The Regional District may require a more extensive quantitative and qualitative report by the Design Professional where unusual conditions or results occur. Further, the RDN may require the information provided by The Design Professional to be reviewed/scrutinized by a third party Design Professional appointed/retained by the RDN and paid for by the developer/well provider.

All new sources of water shall be approved by the Vancouver Island Health Authority (VIHA) and a "source approval" must be issued by VIHA prior to the source being connected to the Regional District of Nanaimo's public water system. VIHA must also approve the well for service in writing. The connection of new properties requiring a new approved source of water shall not be permitted/approved by the RDN until the source is approved by VIHA. A wellhead protection (WHPR) report suitable to the RDN and in the format shown as "**Minimum Requirements**" shall also be submitted along with the information provided for source approval. Any requirements imposed by VIHA in the source approval shall be completed by the Developer, unless agreed to otherwise in writing by the RDN.

The RDN shall own the property as fee simple around the well head for a minimum of 30 meters from the centre of the production well or wells and preferably 60 meters. If ownership is not possible from the 30 to 60 meter zone then a sanitary control easement satisfactory to both VIHA and the RDN shall be provided for this area.

New sources shall also include provision of a suitable monitoring well that shall be designed and placed near the production well as recommended and designed by the Design Professional. The monitoring well shall be suitably completed and secured at the surface with a Model Solonist Gold (or other model if approved in writing by the RDN) electronic data logger placed at a suitable depth in the monitoring well.

2. Surface Water Source

The proposed use of surface water as a potable water supply source shall be approved by the Board before being considered. Any surface water source shall meet all provincial government regulations and guidelines for siting, for licensing and for treatment etc.

3. Source Pump Stations and Controls

Due to the individual requirements for source pump stations, a standard detail drawing is not provided in these Community Water System Standards. Prior

to completing the preliminary design, the design engineer shall request samples of typical recent acceptable source pump stations, and confirm conceptual design requirements. This will be further reviewed, and requirements confirmed by the RDN at the feasibility design review stage.

Wellhead piping shall consist (as a minimum) of a wye strainer, turbine flow meter, air release valves, check valve, gate valve to throttle flows to recommended output with pressure gauges upstream and downstream and mating flanges with adapter coupling to allow installation of an orifice plate to fine-tune pump output, and a 50 mm (2 inch) diameter valved outlet with 62 mm (2.5 inch) diameter fire hose adapter for flushing purposes. A hose bib shall be provided to permit periodic water sampling. The wellhead building or enclosure shall be designed such that future access to the well is available for pump removal or well redevelopment. This shall normally be achieved by installing a pitless adapter on top of the well, protected from vandalism by installation in a non-confined space concrete chamber with spring-assisted aluminum cover and locking lid. A Model Solonist Gold (or other model if approved in writing by the RDN) electronic data logger shall be installed in the well, with data recording equipment and software. Access to install a well-line into the well for periodic manual monitoring of static and pumping levels in the well shall also be provided. Flow recording instrumentation is required. Surface source piping shall be similar in general concept to wellhead piping, modified as agreed with the RDN and to suit the special site circumstances.

The source pump station building shall be designed to provide adequate heating and insulation, lighting and ventilation. The size of the building shall be discussed and determined at the time of the feasibility review. The building shall be of concrete and block work construction, with two isolated rooms, each having separate access doors. One room shall house mechanical piping and electrical controls, and the second room chlorine injection equipment and liquid chemical storage with built-in spill containment. In special circumstances only, the RDN may approve the use of enclosures in lieu of a building, due to site space or access agreement limitations.

Each pump shall have a variable frequency drive combination motor starter with a motor circuit protector, a "hand-off-auto" selector switch, a green "pump run" pilot light, a red "pump failed" pilot light and an elapsed time meter.

Motor starters for submersible well pumps shall be equipped with quick-trip overload relays. Low level draw-down protection shall be provided utilizing electrodes suspended in the well. Restart of the pump shall be automatic when the water level in the well has recovered sufficiently; however, a red alarm light on the control panel shall require manual reset.

If the system consists of more than one pump, supplied from the same service, the control circuits shall be subdivided into branch circuits in such a manner as not to shut down the entire system if one pump circuit develops a fault. Also, time delays shall be provided to permit staggered re-start of the pumps after a power failure.

The pump control panel shall have protection against single-phasing and a red pilot light which will stay on until manually reset after a power failure.

If the system consists of more than one pump, an automatic alternator or manual lead pump selector switch shall be provided.

A single-pole, double-throw (SPDT) contact shall be provided for remote alarm purposes, which will be activated in the event of pump failure, motor overload, and power failure of low well level. Connection of alarm signal outputs to the RDN answering service or alarm centre shall be provided. An external alarm light may also be required for some installations.

Signal cables for pump control shall be directly buried, either alongside connecting pipelines or in a separate trench, wherever feasible. Cable warning tape shall be installed in the trench over signal cables.

For well sources on new systems where very little water-use occurs during the initial operation period until sufficient new users are connected, the RDN may require installation of an approved automatic flushing device, to help in maintaining water quality.

Supervisory control and data acquisition (SCADA) shall be provided from all data outputs to a central location within the new system, normally at the source pump station. The RDN will be responsible for connection of local data to a centralized system, and for any offsite programming requirements which may be required to integrate the new system into the overall water systems SCADA system.

The RDN may require emergency power back-up on all new water sources. This will be determined at time of feasibility review by analyzing system vulnerability.

2.7 Storage

1. Sizing

Reservoirs shall be sized to provide usable water storage volume to meet the fire flow requirements (Section 2.2.1.3) plus 20 percent of a maximum day's demand for the tributary area, and shall be of at least 365 cu. m (80,000 imperial gallons) capacity. The RDN may agree in writing to reduce the reservoir minimum size requirement.

2. Design

The materials and designs used for finished water storage structures shall provide stability and durability as well as protect the quality of the stored water. Unless one or more reservoirs in the same or higher pressure zone within the system are already operational, the reservoir is to be constructed with two independent cells. This is to allow maintenance of one cell to occur, while the second cell remains in service. During the feasibility review, the reservoir design, security features, dimensions, layout and material of construction shall be discussed and agreed with the RDN. Where practical, concrete reservoirs are preferred (although other materials of construction will be considered for acceptance) provided they are designed in accordance with the Building Regulations of British Columbia and amendments thereto. When topography and pressure zone conditions allow, an in-ground reservoir with a minimum 500 mm gravel and soil covering is preferred, for improved

seasonal water quality. Steel structures shall also follow the current AWWA Standards concerning steel tanks, standpipes, reservoirs, and elevated tanks wherever they are applicable.

The foundation may be designed either with the bottom at ground level, bearing on a slab or ring beam or on legs with the bottom in an elevated position.

Foundation design shall be in accordance with Building Regulations of British Columbia and amendments thereto. A foundation or soils investigations report shall be submitted, prepared by a Geotechnical Engineer registered in the Province of British Columbia.

In addition to the seismic requirements of the Building Regulations of British Columbia due account shall be taken of the effects of both convective and impulsive forces generated by ground motion. Sufficient clearance shall also be provided between high water level and roof soffit to allow for wave generation.

The reservoir structure shall be designed to safely withstand all construction and operating loads.

Reservoirs shall be totally enclosed with adequate ventilation, screened and weather protected. Vents shall project above the highest anticipated depth of snow on the roof.

Concrete reservoirs shall be provided with a roof access hatch served by internal and external ladders. Steel reservoirs shall be provided with a roof access hatch served by internal and external ladders and low level access manhole. Roof access hatches shall be of aluminum with spring-assisted opening, and shall be lockable. A roof mounted plate shall be installed alongside the roof access hatch, to suit mounting of the RDN mobile safety winch mechanism, used during internal access operations.

Access ladders, safety cages, and platforms shall comply with the requirements of the Worker's Compensation Board. Chain link and barbed wire fencing of the reservoir site will be required by the RDN, unless otherwise approved in writing by the RDN for specific site location and security conditions.

An altitude gauge shall be provided at an elevation of 1.2 m above the reservoir foundation.

Inlet piping is to discharge into the reservoir above TWL elevation. An approved outlet set 100 mm above the reservoir floor, a valved drain set at floor level, and an overflow pipe with bell-mouth entry set at 200 mm above normal reservoir top water level with 300 mm clearance from underside of roof shall be provided.

Alarms requiring manual reset shall be provided to indicate reservoir high or low level. In a water system consisting of well or booster pumps, these alarms shall be transmitted along buried signal cables to a central location. Controls may utilize probes or transmitters. Where the reservoir is supplied via pumped water, pump start-stop controls will be required. The RDN may

require individual start-stop levels for each pump, or staggered pump start-stop on a timer basis.

The Regional District will require the installation of flow meters with flow data transmission and recording from the reservoir outlet. Level monitoring and recording from a level transducer at the reservoir base, or in a chamber immediately on the outlet pipe, shall also be provided.

2.8 Water Distribution Piping

1. Materials

Unless otherwise permitted, the following pipe materials shall be used for water distribution:

Material	Specifications
Steel Pipe	AWWA C200
Ductile Iron Pipe	AWWA C151
PVC Pipe	AWWA C900 - Class 150, DR 18 maximum

All pipe shall be delivered to site with end caps for shipping and storage. Steel pipe shall be coated and lined in accordance with AWWA C203. Ductile iron pipe shall be cement mortar lined in accordance with AWWA C104. Joints shall be rubber gasket in accordance with AWWA C111. Where corrosive soil conditions exist and metal pipe materials are proposed for use, a soil corrosion survey shall be undertaken by an approved professional. The Regional District may require special protection for the pipe. All pipes shall be designed for the maximum pressures and earth loading to which the pipe will be exposed, but in no case shall the design working plus safety factor pressure or class be less than that providing an AWWA standard rating of 1030 kPa (150 psi). Lesser pressure class pipe may only be used when specifically approved otherwise by the RDN for large installations, where no possibility of pressure surges or pressure zone changes occurring, in which cases Class 100 or better rating pipe would be considered.

2. General Layout

Numerous trunk lines and secondary feeders shall be installed throughout the system. These mains must be large enough to deliver consumption and fire flow demands for the district served, and shall be spaced not more than 900 m apart and looped.

Minor distributors and pipes of the gridiron system shall be a minimum of 150 mm in diameter in residential districts with 150 mm diameter cross mains at intervals not exceeding 180 m. Where no longer lengths of pipe are necessary, 200 mm diameter or larger intersecting main shall be used unless initial pressures are unusually high. 200 mm diameter pipe shall be used where dead ends or poor gridironing are likely to exist for a considerable period, or where the layout of the streets and the topography are not adapted to the above arrangement. Lines furnishing domestic supply only, and not serving hydrants, may be 100 mm diameter. Mains in cul-de-sacs shall be looped wherever feasible by connecting through specifically created rights-of-way or parkland, or by twinning pipe installation and looping pipe ends, for improved water quality. Where a water main ends in a dead end, or a valve is

normally closed, a fire hydrant or below ground flushout shall be provided for flushing purposes. Temporary above ground flushouts may only be used on those mains intended to be extended in the near future.

In the high value districts, the minimum size shall be 200 mm diameter. Pipe of minimum 250 mm or 300 mm diameter is to be used on major and network highways and roads as identified in the Official Community Plans of the Regional District and for long lines not cross-connected.

2.9 Service Connections

Unless otherwise permitted, only the following materials may be used for service connections:

Material	Specifications
Polyethylene, PE 3406 - N	Potable Series 160 B. 137.1
Plastic	ASTM D2666
Soft Copper, Type K	ASTM B88

In general, polyethylene shall be used for new services, except in special approved circumstances, and copper for replacement of existing old service piping by trenchless "pipe splitting" methods.

The minimum size of service connection is 19 mm diameter. Where the length of service between the main and anticipated building frontage exceeds 30 m, the service connection shall be minimum 25 mm diameter. Corporation and curb stops shall be of the same diameter as the service piping. In the larger sizes of service connection piping, the materials specified in Section 2.8 for water distribution may also be used.

Drawing W-7 of this Schedule shows the general arrangement for water service connections. The minimum size of service connection is 20 mm diameter.

Water service connection locations shall be co-ordinated with B.C. Hydro, TELUS (Telephone Company), and Shaw Cablesystems to avoid any conflict with poles (or proposed underground facilities and service conduits for underground utility installations) at the property lines of parcels. Similarly, conflict with Terasen (gas) services shall also be reviewed and avoided.

1. Corporation Stops

Corporation stops shall be in accordance the following supplementary data:

- a) Full port ball valve.
- b) Minimum 150 psi rating.
- c) AWWA x compression.
- d) Compression nut machined to bottom out on valve body shoulder.
- e) Saddle clamps shall be used as specified by the manufacturer.

2. Curb Stops

Curb stops shall be in accordance with the following supplementary data:

- a) Full port ball valve.
- b) Minimum 150 psi rating.

- c) Compression x meter swivel nut.
- d) Compression nut machined to bottom out on valve body shoulder.
- e) Integral lockwing.
- f) Drain holes not permitted.
- g) Set on main side of meter box to facilitate meter installation when required.
- h) Curb stops shall initially be set in a 100 mm diameter PVC riser pipe, with the meter box to be installed by the RDN on final connection when the building is under construction, unless agreed otherwise. Concrete meter boxes with full support lip and steel lid drilled for touch-read meter pad shall be provided to the RDN for this purpose.

2.10 Fire Hydrants

Hydrants shall be in accordance with AWWA C502, compression type, factory-painted yellow. The minimum hydrant size shall be 150 mm diameter. The minimum depth of bury shall be 1.2 m. There shall be a minimum of two 65 mm house outlets and one pumper outlet 117.5 mm P4.23, outside diameter male outlet complete with caps per hydrant. One of the outlets shall have an independent shut-off. Opening for both the main hydrant valve and independent shut-off shall be to the left (counter-clockwise). Outlet threads shall conform to the British Columbia Fire Hose Thread Specification. Main valve spindle and outlet nuts shall be standard pentagon shape. Main valve spindle: pentagon in 45 mm circle. Independent spindle: square 16 mm x 16 mm. Drain outlets are to be provided.

Drawings W-12 and W-13 of this Schedule show the general arrangement for the installation of hydrants. Connections shall not be less than 150 mm diameter. A gate valve will be provided on all connections between the hydrant and the main. Installations shall be in general accordance with AWWA M17. The hydrant shall be installed vertical, with the pumper nozzle perpendicular to the priority access road centreline. Mechanical joint thrust restrainers shall be used on all leads up to 6 m length. For longer hydrant leads, approved joint restrainers shall be used at each pipe joint, or alternatively a thrust block shall be installed behind the hydrant 'boot' in accordance with Drawing W-9.

Hydrant distribution shall be in general conformance with the aforementioned Standard of Municipal Fire Protection, but in all cases spacing shall be such that the maximum distance from a hydrant to the centre of any property measured along the centreline of the street and at right-angles to the property is 75 m. Hydrants will be set in 6 m from the corner at any intersection to facilitate future widening or other street works.

2.11 Valves

Unless otherwise permitted, only the following valves shall be installed in the distribution system:

1. Gate Valves

Gate valves shall be in accordance with Drawing W-8, AWWA C500 and the following supplementary data:

- a) Gate valves shall have an iron body, brass mounted.

- b) Valves shall be the same size as the pipe in which they are installed, up to and including 300 mm diameter. In mains over 300 mm diameter, valves may be butterfly type.
- c) Valve ends shall be provided to fit the pipe.
- d) The position of the in line valve shall be vertical.
- e) Stem seals shall be O-ring.
- f) Valves shall open to the left (counter-clockwise).
- g) Gears will be required on valves 400 mm and larger. Gear cases shall be totally enclosed.
- h) Bypasses will be provided on valves 500 mm in diameter and larger.
- i) Valves shall have a 50 mm square operating nut.

2. Rubber Seated Butterfly Valves

Rubber seated butterfly valves shall be in accordance with AWWA C504 and the following specifications:

- a) Valves shall be the same size as the pipe in which they are installed. Valves shall be of wafer style or short body flanged.
- b) Valve ends shall suit the pipe.
- c) Maximum nonshock shutoff pressure shall be suitable for 1030 kPa, bubble tight.
- d) Valves shall be designed for the extreme maximum flows for both opening and closing.
- e) Shaft seals shall be O-ring type.
- f) Valve disks shall be ductile iron.
- g) Valve operators shall be suitable for buried installation and equipped with a standard operating unit.
- h) Valves shall open to the left (counter-clockwise).
- i) Operators are to be located on the side of the valve with the operating spindle in the vertical position.

In general, valves shall be located at intersections and shall be so positioned that no more than 150 m for high value district and 250 m for other areas are isolated in the case of line repairs. In larger trunk and feeder mains where no interconnections are made, the spacing of valves should not exceed 500 m.

Approved joint restraint fittings shall be provided on all valves.

Where valves are located in the roadway, valve boxes shall be Nelson Type of cast iron and telescoping so the surface loads are not transmitted to the valve body of pipeline. A minimum of 200 mm of future adjustment shall be available on all valve boxes for future raising of grade, by locating the top of PVC riser a maximum of 100 mm below the completed asphalt apron grade at the time of initial installation. Cast iron hoods shall be provided on all gate valves 250 mm diameter or larger. In areas where there is no traffic, valve boxes may be as approved by the Regional District.

Valve markers shall be installed to indicate the location of all valves. These markers shall be constructed of 50 mm metal pipe painted sky blue and set in a concrete base. They shall extend 1 m above the ground

surface. The markers shall be located 2 m from the property line opposite the valve and the distance to the valve is to be marked in black figures on a flattened upper portion of the marker.

2.12 Fittings

Fittings shall be designed for a minimum of 1030 kPa working pressure and shall be in accordance with AWWA C110. Ends shall be flanged or belled to suit pipe ends. Flanges shall conform in dimension and drilling to ASA B16.1, Class 125. Flange gaskets shall be of natural rubber and shall be 3mm thick with a layer of cotton on both sides. Approved joint restraints shall be used at all fittings, including restraining of a suitable length of pipe each side of the fitting, except at fire hydrant leads over 6 m with unrestrained pipe joints and at main dead-ends, where thrust blocks shall be provided as shown on Drawing W-9 of this Schedule. Thrust calculations for joint restraints shall be carried out in accordance with the manufacturer's specifications, and shown on the design drawings. Length of pipe to be restrained at each fitting shall be clearly shown on each applicable plan drawing, for the varying pipe sizes and fitting configuration.

2.13 Trenching and Backfill

The standard trench section is shown in Drawings W-1, W-2, and W-3 of this Schedule for various conditions. The nominal minimum depth of cover shall be 1.2 m but in no case shall it be less than 1.0 m unless otherwise permitted by the Regional District. Water mains shall be located not less than 3 m centre-to-centre from all sanitary and storm sewer lines, unless otherwise permitted by the Regional District and the Vancouver Island Health Authority.

1. Bedding material shall conform to the following gradation limits:

Gradation Limits
(Percent by Weight Passing)

Sieve Designation	Type 1	Type 2
19.0 mm	100	90-100
12.5 mm		65-85
9.5 mm	85-100	50-75
4.750 mm	70-100	25-50
2.36 mm		10-35
1.18 mm	20-65	
0.850 mm		5-20
0.6 mm	0-45	
0.425 mm		0-15
0.18 mm		0-8
0.15 mm	0-10	
0.075 mm	0-5	0-5

2. Type 1 is the standard acceptable bedding material. Type 2 shall be used where specified by the design engineer to meet special design loading. Dry sieve analysis shall be carried out in checking material gradation.
3. Other acceptable bedding materials, for use only where shown on the construction drawings or as approved by the Engineer, are drain rock, pea gravel or native material. In rock, pipe zone shall have filter fabric between rock and bedding material. Filter fabric shall be non-woven, minimum grade Armtec 200 or equivalent.
4. The bedding material shall cover the full width of the trench bottom and have a minimum depth of 100 mm on completion of compaction. In rock excavation the minimum depth of bedding below the pipe shall be 150 mm after completion of compaction.
5. Bedding material shall be compacted in maximum 150 mm lifts to 95% of Modified Proctor Density (ASTM D1557). Side tamping shall be carried out with bedding material placed to the pipe springline, to provide haunch support.
6. Bedding material shall be placed in such a manner that the pipe is evenly supported throughout its length by the pipe bedding material.
7. Placement and compaction of the bedding material shall not damage or displace the pipe.
8. Bedding material shall be leveled across the full width of the trench to an elevation of 300 mm above the crown of the pipe.

2.14 Pressure Reducing Stations

General requirements for pressure reducing stations shall be as follows:

1. A valved bypass shall be provided.
2. A surge relief valve shall be provided to release pressure in the event of a failure of the pressure reducing valve(s). The surge relief valve may be incorporated into the pressure reducing station or may be located at some other suitable location within the distribution system.
3. Pressure reducing valves shall be sized to provide adequate pressure control through all ranges of design flows. If necessary, two or more pressure reducing valves of varying sizes will be provided in the one station.
4. Each pressure reducing and surge relief valve will be provided with isolating valves and be installed so that individual components may be easily removed for repair or replacement.
5. The whole of the pressure reducing stations shall be enclosed in a reinforced concrete vault with a standard manhole cover and other opening large enough to remove the largest single piece of equipment in the station. Floor drains sloped at 2 percent shall be provided to keep the station dry at all

times and shall not be directly connected to any sanitary sewer, or to a storm sewer without a backwater valve in the storm service connection. Drains to the surface are permissible if there is no risk of flooding. Otherwise, underground absorption pits or sump pumps will be required depending on site condition. A permanent access ladder shall be installed.

6. Pressure gauges complete with snubbers shall be installed to register both upstream and downstream pressure.
7. Adequate strainers with dual cartridge filters shall be supplied on the water used for controlling and regulating valves.

2.15 Booster Pump Stations

General requirements for booster pump stations shall be as follows:

1. A valved bypass shall be provided.
2. There shall be sufficient capacity so that, with the most important pump out of service, the station will be capable of supplying the maximum design flow.
3. It may be requested that provision be made to provide the maximum design flow during a power failure. Normally this will be accomplished by means of an elevated storage tank. Where this is not possible, emergency standby internal combustion engines shall be installed either for direct drive or electric generation.
4. Where design flows are such that starting and stopping surges will cause water hammer in the inlet or discharge lines, pump control valves or other pressure control devices shall be provided. Relief valves will also be required to protect against surges caused by power failure.
5. Pumps shall be controlled by automatic devices satisfactory to the Regional District. Flow and pressure measurement shall be provided where required. Flow recording may be required for some installations. Signal cable for pump control shall be directly buried, either alongside connecting pipelines or in a separate trench, wherever feasible. Cable warning tape shall be installed in the trench over signal cables.
6. Pumps shall normally be housed in above ground buildings, designed to provide adequate insulation, heating, lighting and ventilation.
7. Each pump shall have a combination motor starter with a motor circuit protector, a "hand-off-auto" selector switch, a green "pump run" pilot light, a red "pump failed" pilot light and an elapsed time meter.

If the system consists of more than one pump, supplied from the same service, the control circuits shall be subdivided into branch circuits in such a manner as not to shut down the entire system if one pump circuit develops a fault. Time delays shall be provided to permit staggered re-start of the pumps after a power failure.

The pump control panel shall have protection against single-phasing and a red pilot light which will stay on until manually reset after a power failure.

If the system consists of more than one pump, an automatic alternator or a manual lead pump selector switch shall be provided. Time delays or other means suitable to prevent hunting on momentary pressure surges shall be provided.

The pumps shall be shut down and stay locked in the event of motor high temperature or motor overload. The pumps shall also shut down on low suction pressure, however, re-start shall be automatic when the section pressure recovers, except that a red pilot light shall stay on until manually reset.

A single-pole, double-throw (SPDT) contact shall be provided for remote alarm purposes, which will be activated in the event of pump failure, motor high temperature, motor overload, low suction pressure, power failure or standby engine failure (if applicable). Connection of alarm signal outputs to the RDN answering service or alarm centre shall be provided. An external alarm light may also be required for some installations.

2.16 Water Meter Chambers

General requirements for meter chambers on services of 37 mm diameter and larger shall be as follows:

1. An approved meter and double check backflow preventer shall be provided. The meter shall be touch-read style, conforming to the standard meter manufacturer and reading system used by the RDN.
2. Meters shall be sized to meet the anticipated maximum demand required, while providing accurate metering throughout the flow range. Compound meters, or large and small meters installed in parallel, may be required to meet these requirements, particularly where fire flows are to be metered. Pressure loss and maximum velocities shall also be examined. For systems supporting in-building wet fire sprinkler systems, available pressures during flow conditions shall be examined, to ensure adequate operating pressure is maintained at the sprinkler heads.
3. The meter shall be installed in a chamber or chambers, which are of non-confined space access design. Large lids shall be spring-assisted opening, suitable to carry traffic loading unless the location is totally isolated from existing or future traffic, of aluminum construction when feasible.
4. If a sidewalk location is unavoidable for the meter chamber, the box shall be situated to maximize the unobstructed walking corridor.
5. The meter shall be installed in a horizontal plane.
6. A valved by-pass shall be provided for meters 50 mm diameter and larger, to avoid service shutdown during meter maintenance. For combination domestic and fire flow meters, the by-pass shall be sized for the largest flow rate. By-pass and isolation valves may be installed external to the meter chamber.
7. Meter box lid shall be suitable for mounting a touch pit read pad.

3. CONSTRUCTION

3.1 General

1. Access Roads

Temporary roads shall be constructed as required for access to the working areas. Adequate drainage facilities in the form of ditches, culverts, or other conduits shall be installed as found necessary to maintain these roads. In the construction of access roads, existing drainage facilities, natural or otherwise, shall not be disturbed to the detriment of properties outside the working area and such facilities shall, unless otherwise provided elsewhere in the specifications, be restored to their original condition on completion of the work.

2. Sanitary Facilities

Clean, sanitary latrine accommodations shall be provided and shall be located and maintained in accordance with the regulations of VIHA.

3. Special Tools, Operating Manuals, Shop Drawings

With each piece of mechanical and electrical equipment or machinery having wearing parts and requiring periodical repair and adjustment, all special tools, wrenches, and accessories required for removing worn part, making adjustments, and carrying out maintenance shall be supplied. All gauges, indicators, and lubricating devices necessary for the proper operation of the equipment shall be furnished.

With each piece of equipment, four sets of operating manuals and as-constructed shop drawings shall be supplied. The manuals shall provide the manufacturer's recommended maintenance schedules with the grades of lubricants required, and instructions as to how the equipment may be taken apart for periodical inspection and replacement.

4. Blasting

Blasting will be permitted only after securing the approval of the applicable authorities. Blasting will not be carried out without first verifying that insurance covers any loss of life or damage that may result from this work. The Regional District, in granting approval for blasting, does not in any way assume responsibility for injury, loss of life, or damage that results there from, and such approval shall not be construed as approval of the methods employed in blasting, the sole responsibility therefore being that of the applicant.

5. Site Maintenance and Clean Up

The working area shall be maintained in an orderly manner and shall not be encumbered with equipment, materials, or debris.

Clean up shall be a continuing process from the start of the work to final acceptance of the project. Property on which work is in progress shall at all times be kept free from accumulations of waste materials or rubbish. Accumulations of waste materials, which might constitute a fire hazard, shall not be permitted. Spillage from hauling vehicles on traveled public or private roads shall be promptly cleaned up. On completion of construction, all

temporary structures, rubbish, and waste materials resulting from the operations, shall be removed.

6. Erosion and Sediment Control

An Erosion and Sediment Control Plan shall be submitted for review and approval seven days prior to the pre-construction meeting. The Erosion and Sediment Control Plan shall describe the proposed methodology to minimize potential impact on the surrounding environment. The Erosion and Sediment Control Plan shall indicate how the Contractor plans to control sediment discharges from the project and what measures will be put in place to prevent damage to aquatic habitat located downstream.

The work shall be carried out in compliance with the submitted and approved Erosion and Sediment Control Plan and all other environmental laws affecting the work and with the recommendations contained in the most recent edition of the "Land and Development Guidelines for the Protection of Aquatic Habitat" published jointly the Ministry of Environment and Fisheries and Oceans Canada.

For the erosion and sediment control plan, 'environmental laws' means all statutes, regulations, orders, and bylaws relating in any way to the natural environment or its ecosystems, public or occupational health, transportation, storage or handling of contaminants or hazardous materials.

3.2 Existing Structures and Utility Works

1. Scope

Existing structures shall be interpreted as being all existing pipes, ducts, ditches, or other works forming a part of sewerage, drainage, water, telephone, electrical, gas, or other utility system, as well as sidewalks, curbs, poles, fences, buildings, and other man-made things that may be encountered during construction.

2. Material Supply

Unless specified otherwise, materials supplied for replacement of existing structures shall be at least equal to those being replaced.

3. Location of Structures

Drawings or descriptions, verbal or otherwise, of existing structures or their location that are supplied by the Regional District are intended only as an aid to locating these structures. Measurements and location of the existing underground structures shown on the drawings are not guaranteed to be accurate, and must be verified prior to proceeding with construction.

4. Protection of Structures

Unless authorization from the Regional District is received for their removal, underground and surface structures encountered during construction shall be protected from damage. In the event of damage resulting from the construction operation, structures shall be repaired or replaced to a condition, which is at least the equivalent of that which existed prior to construction.

5. Emergency Situations

In emergency situations resulting from the construction operation, where life or property are endangered, the applicant shall immediately take whatever action is possible to eliminate the danger, and shall also notify the Regional District of the situation.

6. Access Maintained

Existing hydrants, valve or control pit covers, valve boxes, curb stop boxes, fire or police call boxes, and all other utility controls, warning systems, and appurtenances thereof shall not be constructed or made inaccessible at any time by the construction work. Bridges, walks, or other temporary facilities shall be provided as may be necessary to ensure that these controls or warning systems are free for use in their normal manner at all times during construction.

7. Curtailment of Utility Service

Where existing utilities such as water, sewer, electricity, telephone, and gas are serving the public, work shall be planned and executed such that there is no curtailment of service provided by these utilities without prior receipt of approval of the authorities responsible for provision and maintenance of these utilities. The applicant shall obtain the above approvals from the recognized authorities controlling these utilities. If approval for such disruption of utility service is not granted, it may be possible to establish temporary facilities to provide continuous utility service during the course of construction. Such temporary facilities shall only be implemented after receiving the approval of the utility authority.

If approval is received to temporarily shut off an existing utility, individual users of the utility shall be notified at least one hour prior to the time of shut-off.

If there is going to be a shut-off, the Fire Department shall be notified at least one hour prior to shut-off time.

8. Support of Structures

Existing structures shall be protected against damage from settlement by means of timber support or compaction of backfill as required. Where necessary, timber support shall remain in place following backfill of excavations.

Backfill which is placed under or adjacent to the existing structures, which have been undermined during excavation, shall be compacted in a manner which will prevent damage of the structure from settlement. Such backfill shall be of approved granular material suitable for compaction.

On existing piping, this material shall extend horizontally a minimum distance of 600 mm on both sides of the pipe at a level 300 mm above the pipe, and shall slope down from this point at 1-1/2 horizontal to 1 vertical to meet the bottom of the excavation.

9. Drainage Facilities

Existing culverts, enclosed drains, flumes and ditches, and other drainage structures affected by the work but left in place shall be kept clear of

excavated material at all times during construction. When it is necessary to temporarily remove an existing drainage structure, suitable temporary ditches or other approved means of handling the drainage shall be provided during construction.

3.3 Clearing

Prior to clearing, the exact limits of the areas on which clearing may take place and whether or not there are restrictions placed on clearing which would result in leaving certain trees, structures, or other existing items in place shall be ascertained.

Prior to trenching, the right-of-way shall be cleared of all standing or fallen brush, timber, stumps, or other debris, which may obstruct the construction operation, damage the completed installation, or detract from the appearance of the site on completion of construction. This material shall be burned or otherwise disposed of to the satisfaction of the Regional District.

The restrictions of all authorities established to control burning in the area shall be complied with. If burning cannot be done on the clearing site, the material shall be hauled to an approved location for burning or disposal. Burning permits, as required, shall be obtained by the applicant.

3.4 Trench Alignment and Depth

Following clearing and prior to excavation of the trench, the location at which the pipe shall be installed shall be established by setting stakes at 20.0 m intervals along a line offset from the centre of the proposed pipeline.

Where pipe is to be installed to a predetermined grade, a cut sheet will be provided showing the depth of the pipe invert relative to the grade stake elevation at the respective locations along the pipeline.

The trench shall be excavated so that pipe can be laid to the established alignment and depth, with allowance made for specified trench wall clearances and bedding as shown in Drawings W-1, W-2, and W-3 of this Schedule for various conditions, or otherwise required.

All trenching and excavations shall be carried out in the manner recommended by the Workers' Compensation Board of British Columbia, or as may be necessary to protect life, property, and structures adjacent to the work and the work itself.

3.5 Pipe Installation

In general, and without limiting the clauses set out in this Standard, pipe shall be installed in accordance with the following specifications:

Ductile Iron Main	AWWA C600
Steel Mains	AWWA C603
PVC Mains	AWWA C900

3.6 Trench Backfill

Trench backfill shall be carried out as shown in Drawings W-1, W-2, and W-3 of this Schedule for various conditions.

3.7 Repairs

Any system approved and built to these standards which requires maintenance work, shall be repaired with materials and construction methods conforming to the specifications contained herein.

4. TESTING AND DISINFECTION

4.1 Written Reports

The applicant shall submit reports to the Regional District certified by a Design Professional of the tests and chlorination requirements specified herein.

4.2 Leakage Tests

Following final trench backfilling, leakage tests shall be performed on all installed piping.

Leakage tests shall be carried out between valved sections of the installation such that every valve in the system is tested for leakage in the shut-off position.

Leakage tests shall be performed in the following manner. The section to be tested shall be filled with water and all air expelled from the piping. It is recommended that the test section be filled with water for at least 24 hours prior to testing. By pumping water into the test section, the pressure within the piping shall be increased to 0.7 MPa, or 1-1/2 times the system operating pressure at the point of test, whichever is the greater. This pressure shall be maintained constantly in the pipe throughout the duration of the test by the addition of make-up water. The duration of the test section to maintain the specified pressure over the period of test shall be considered to be the leakage.

Piping will not be accepted until the leakage is less than the maximum allowable leakage determined from the following formula:

$$L = ND \times \text{the square root of } P$$

in which L = the allowable leakage in litres per hour,
N = the number of joints in the test section,
D = the nominal diameter of the pipe in millimetre, and
P = the average test pressure during the leakage test in megapascals.

Should any test disclose leakage greater than that specified above, the defect shall be located and repaired, and the section shall be retested to ensure that the leakage is within the allowable limits.

4.3 Flushing

The pipe shall be cleaned of dirt and other foreign materials. The pipe shall be flushed at water velocities of 1.0 m/s, or as high a velocity as can be obtained from the available water sources. Flushing water shall be discharged to watercourses or ditches that have sufficient capacity to carry the flow. Measures shall be taken to avoid any damage to fish habitat or to fish and other aquatic life.

4.4 Chlorination

On completion of the flushing operation, main pipes and services shall be chlorinated. Chlorination procedures shall conform to AWWA C651.

On completion of chlorination, the entire piping system shall be thoroughly flushed of all highly chlorinated water and filled with normal system water at a slow rate to avoid stirring deposits from existing mains, sampled in accordance with VIHA, and following satisfactory test results left in a condition ready for use.

Water reservoirs and storage tanks shall be disinfected in accordance with AWWA C652, and wells in accordance with AWWA C654.

Chlorinated water shall be disposed of in such a way as to not cause harm or damage to fish, vegetation or aquatic life in bodies of water or water courses; all federal and provincial regulations and/or guidelines on disposing of chlorinated water to the environment shall be followed.

4.5 Inspection

The Regional District shall be given 48 hour notice of all tests and chlorination.

5. TRANSFERRING THE WATER SYSTEM TO THE RDN

5.1 Final Inspection by RDN

Prior to requesting a Final Inspection, the Design Professional shall submit to the Regional District complete Record Documents, a completed Certification of Installed Works, all applicable test results (chlorination, pressure, leakage, health, commissioning, etc.), and Certificate of Approval for electrical works (pump stations, wells, lighting, controls, etc.) The Final Inspection shall be arranged by the Design Professional on completion of the work. This shall be directed by the Design Professional in the presence of approved representatives of the Regional District and the installation Contractor. A complete list of deficiencies identified during the final inspection shall be prepared by the Design Professional. Once the deficiencies have been satisfactorily rectified, the Design Professional shall so notify the Regional District. The date of the Final Inspection will generally be regarded as the commencement of the guarantee period, unless significant deficiencies critical to the effective operation of the system are found at the inspection, at the discretion of the Regional District.

5.2 Preparation/Execution of Transfer Agreement by Developer

The Developer shall prepare and execute a Draft Transfer Agreement for the works and submit the document to the Regional District for review/comment. Once approved by the Regional District the Developer shall complete the document and execute it accordingly and submit to the Regional District for them to execute. The date of the Transfer Agreement shall be the date on which the Regional District executes the document.

5.3 Preparation/Execution of Maintenance Agreement

The Developer shall prepare and execute a Draft Maintenance Agreement for the works and submit the document to the Regional District for review/comment. Once approved by the Regional District the Developer shall complete the document and execute it accordingly and submit to the Regional District for them to execute.

The Developer shall guarantee the workmanship and the performance of the work as per the Maintenance Agreement, from the date of acceptance (generally the date on which the Regional District executes the Transfer Agreement) for a period of two years. This shall be additionally secured by way of cash or an irrevocable letter of credit suitable to the Regional District in the amount of 10% of the cost of construction as certified by the Design Professional or \$10,000.00 (whichever is greater). There will be no interest paid on this security.

The RDN may reduce the length of the guarantee period and/or the amount of the security. The RDN may also require additional payment, or payout a credit as appropriate, related to an adjustment of the initial engineering fee to final construction cost values, in accordance with RDN Bylaw 1259.03 or most recent amendment. Any change to the guarantee period, security amount or the engineering fee is required to be in writing.

5.4 Preparation/Execution of Latecomer Agreement

Where a latecomer agreement may be applicable to a portion of the costs of the works, as agreed by the Regional District and any other applicable jurisdictions, the Developer shall pay all costs of both the Regional District and the Developer associated with the preparation, execution, and registration of the necessary Latecomer Agreement. The Regional District will assume any internal staff costs involved in planning, reviewing, approving, and administering the Latecomer Agreement preparation, and any administrative and financial costs involved during the effective time-period of the agreement. Based on current legislation, a Latecomer Agreement expires 10 years after its initial registration.

5.5 Letter of Acceptance of the Works by RDN

Following completion of all the foregoing requirements, the Regional District will issue the formal **Letter of Acceptance of the Works**.

The Regional District will also issue a written statement that the new works can be connected to the District's existing system. Such connection shall be undertaken by the applicant under the direct supervision of the District or by the District at a cost to the applicant.

**REGIONAL DISTRICT OF NANAIMO
BYLAW NO. 500**

SCHEDULE '7D'

COMMUNITY WATER SYSTEM STANDARDS

APPENDIX 1

SUBDIVISION SERVICING AGREEMENT

REGIONAL DISTRICT OF NANAIMO
SUBDIVISION SERVICING AGREEMENT
(List the Name of Subdivision or Development here)

THIS AGREEMENT made the ____ day of _____, 20 ____
(hereinafter called the "Agreement")

BETWEEN:

REGIONAL DISTRICT OF NANAIMO

6300 Hammond Bay Road
Nanaimo BC
V9T 6N2

(hereinafter called the "Regional District")

OF THE FIRST PART

AND

(hereinafter called the "Developer")

OF THE SECOND PART

WHEREAS the Developer is the registered Developer or holder of a Registered Right to Purchase lands and premises situate, lying and being in the Regional District of Nanaimo, Province of British Columbia and more particularly known and described as:

(legal description)

(hereinafter called the "Lands")

AND WHEREAS the Developer wishes to subdivide the Lands, or part thereof, in the manner shown on a Subdivision Plan, which has been submitted by the Developer to the Provincial Approving Officer for approval. A copy of said plan is attached hereto as Appendix "A", and is hereinafter called the "Subdivision Plan";

AND WHEREAS the Developer is desirous of entering into this Agreement with the Regional District pursuant to the provisions of Section 940 of the Local Government Act in order to obtain approval from the Provincial Officer for the Subdivision Plan prior to the completion of the construction and installation of all works required under the provisions of the Land Use and Subdivision Bylaw to be constructed and installed by the Developer.

Initial	Initial
---------	---------

NOW THIS AGREEMENT WITNESSETH that in consideration of the premises and of the mutual covenants and agreements herein contained, the parties hereto covenant and agree as follows:

1. In this Agreement, unless the context otherwise requires all words and expressions shall have the same meaning assigned to them as like words or expressions contained in the Interpretation Section of the Regional District of Nanaimo Land Use and Subdivision Bylaw No. 500.
2. The Developer covenants and agrees to retain the services of a qualified professional engineer registered in the Province of British Columbia (name of engineering company retained) to complete the design, construction and supervision of construction complete with all necessary inspections and testing to ensure the project is constructed to the design parameters and specifications. The Developer shall not terminate the services of the professional engineer without the written consent of the Regional District.
3. The Developer covenants and agrees to construct and install on the Lands and off-site, as the case may be, in accordance with the plans and specifications marked "Approved For Construction" by the Regional District Engineer and initially by each of the parties hereto for identification, the following work:

- _____ community sanitary sewage works
- _____ community water works
- _____ community street lighting works

Each of the parties hereto acknowledge having in its or his possession a true copy of the aforesaid plans and specifications, hereinafter called the "Approved Engineering Plans", and acknowledge and agree that the "Approved Engineering Plans" are hereby incorporated into and make part of this agreement and are attached as Appendix "B".

4. The Developer covenants and agrees that upon substantial performance of the work as certified by the Developer's Engineer and approved by the Regional District Engineer, the Developer will enter into a Maintenance Agreement, including the holding of 10% of the total amount of works and service or \$10,000 (whichever is greater), to warrant for the maintenance of the work against defects arising from faulty installation, materials or workmanship for a period of twenty-four (24) months (*may be reduced in writing by the Regional District from the date of substantial performance as approved by the Regional District*).
5. All work must be carried out by the Developer or his contractors in accordance with the "Approved Engineering Plans", and in accordance with the provisions of the RDN Land Use and Subdivision Bylaw No. 500, or latest version. Where the provisions of the "Approved Engineering Plans" and the RDN Subdivision and Development Bylaw conflict, the more stringent provisions shall apply.
6. The cost of all work herein shall be at the expense of the Developer. The Developer must employ only qualified contractors to carry out and complete the work.
7. The Developer must obtain and provide to the Regional District upon request and free of charge true copies of all contracts and sub-contracts entered into by the Developer or its contractors and relating works.

Initial	Initial
---------	---------

8. The decision of the Regional District Engineer shall be final and binding on all parties hereto in determining whether or not the work or any part thereof has been carried out and completed in accordance with the provisions of this Agreement.
9. As soon as the Developer is satisfied that he has caused the work to be completed, and prior to issuance of a "Certificate of Substantial Completion", the Developer shall submit to the Regional District Engineer:
 - a. Final "As Constructed" drawings of all work constructed hereunder, sealed by a British Columbia professional engineer and comprised of the following: a mylar copy, an electronic copy in AutoCAD format compatible with the latest version owned by the RDN, two full size paper copies, two 11 x 17 inch paper copies and one TIFF file.
10. The Developer shall cause all work herein to be carried out and completed not later than the ___ day of _____, 20___. (Hereinafter called the "Completion Date")
11. Prior to final approval and as security for the due and proper performance by the Developer of all his covenants and agreements herein contained, the Developer shall deposit with the Regional District an unconditional, Irrevocable Letter of Credit, in a form acceptable to the Regional District of Nanaimo, or cash, drawn on a chartered bank in Canada for a term of not less that twenty-four (24) months. The letter of credit shall be in the amount as specified in Section 4. The Irrevocable Letter of Credit is attached as Appendix "C".
12. The Developer agrees that if the work, or any part thereof, is not completed in accordance with the provisions of this agreement by the "Completion Date", or if the Developer shall be in default of any of his covenants herein contained, and such default shall continue for a period of fourteen (14) days after notice thereof has been given by the Regional District to the Developer, the Regional District may call for and receive funds secured by the Letter of Credit and the Regional District may complete the work at the expense of the Developer and deduct from any fund held by the Regional District as security hereunder, the cost of such completion, and the balance of the security, if any, will be returned to the Developer less any administration fees and costs incurred by the Regional District. If there is insufficient money on deposit with the Regional District by reason of the security deposit, then the Developer will pay such deficiency to the Regional District immediately upon receipt of an invoice from the Regional District. It is understood and agreed that the Regional District may do such work either by itself, or by contractors employed by the Regional District.
13. The Regional District may consent to a reduction in the amount secured by the Letter of Credit, or cash, from time to time in accordance with the following:
 - a. The credit reduction will be equal to the cost of work completed, minus a 10% holdback, as submitted by the Developer's engineer and as approved by the Regional District Engineer; and
 - b. No reduction will be allowed for an amount, which represents less than 10% of the total cost of construction and installation of the work.
14. The Developer covenants and agrees to indemnify and save harmless the Regional District, its Board, officers, agents and employees from and against all actions, proceedings, costs, damages, expenses, claims and demands whatsoever and by whomever brought or made against the Regional District or its Board, officers, agents and employees, relating directly or indirectly from the design, construction, or installation of the work.

Initial	Initial
---------	---------

15. The Developer acknowledges and agrees that the Regional District will not issue Building Permits on any of the parcels created by the subdivision of the Lands, and no building shall occur on the Lands until the Regional District Engineer has issued the “Certificate of Substantial Completion”.
16. The Developer covenants and agrees that the Developer shall give all prospective purchasers a copy of this agreement and bring their attention to Section 14 of this agreement which restricts their ability to apply for a building permits
17. In consideration of due and proper performance by the Developer of his covenants herein contained, the Regional District covenants and agrees to permit the Developer to carry out and perform the work.
18. Any demand or notice required or permitted to be given under the provisions of this agreement must be in writing and may be given by mailing such notice by prepaid registered post to the party concerned at the address for such party first above recited, and any such notice or demand mailed as aforesaid must be deemed to have been received by the party to whom it is addressed on the second business day after the date of posting thereof.
19. The Developer acknowledges and agrees that the works become the property of the Regional District by entering into a Transfer Agreement or the agency having jurisdiction subject to no encumbrances upon issuance of a “*Certificate of Substantial Completion*”, by the Regional District Engineer. Notwithstanding the above, nothing herein contained must derogate from the obligation of the Developer to warrant for the maintenance of the work against defects arising from faulty installation, materials, or workmanship for a period of twenty-four (24) months following the date of substantial performance as aforesaid.
20. It is understood and agreed that the Regional District has made no representations, covenants, warranties guarantees, promises or agreements, oral or otherwise, with the Developer other than those contained in this contract.
21. Wherever the singular or masculine is used herein, the same must be construed as meaning the plural, feminine, or body corporate or politic where the context or the parties so require.
22. This Agreement and the terms, covenants and conditions herein contained shall enure to the benefit of and be binding upon the parties hereto and their respective heirs, executors, administrators, successors and assigns.

Initial	Initial
---------	---------

IN WITNESS WHEREOF the parties hereto have executed this Agreement at the Regional District of Nanaimo, Province of British Columbia, the ____ day of the _____, 20__.

Executed by the)
REGIONAL DISTRICT OF NANAIMO)
this ____ day of _____, 20__)
by its authorized signatories:)

_____)
Carol Mason, Chief Administrative Officer)
)
)
)

_____)
Maureen Pearse, Senior Manager)
Corporate Administration)

Executed by The Developer)
this ____ day of _____, 20__)
by its authorized signatories:)

_____)
)
)
)
)
)
)
)
)

Initial	Initial
---------	---------

Appendix "A"
SUBDIVISION PLAN



Initial	Initial
---------	---------

Appendix “B”

APPROVED ENGINEERING PLANS

Initial	Initial
---------	---------

Appendix “C”

IRREVOCABLE LETTER OF CREDIT

Initial	Initial
---------	---------

**REGIONAL DISTRICT OF NANAIMO
BYLAW NO. 500
SCHEDULE '7D'**

**COMMUNITY WATER SYSTEM STANDARDS
APPENDIX 2
STANDARD DRAWINGS**

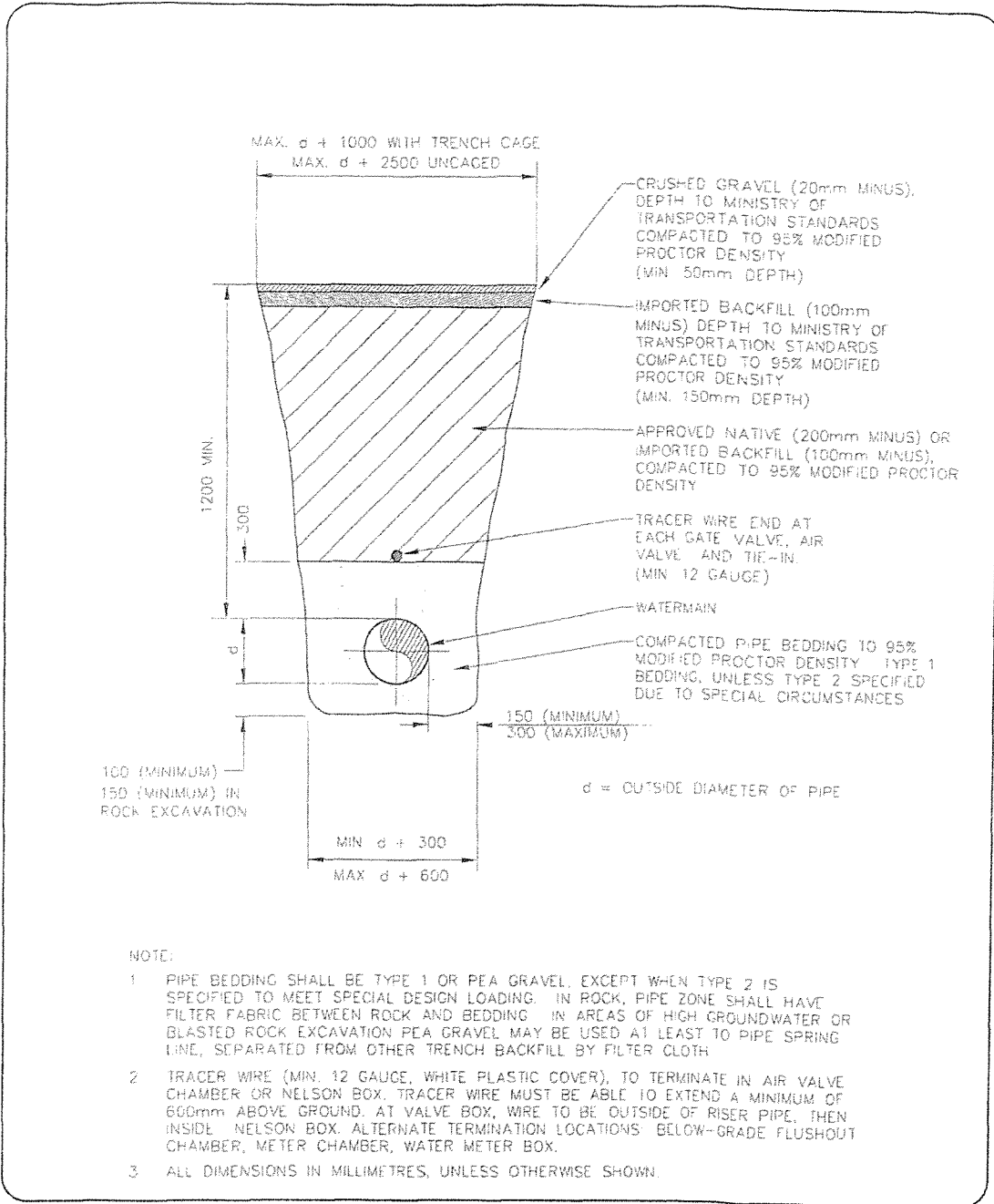

 **BYLAW No. 1562**
COMMUNITY WATER SYSTEM STANDARDS

TRENCH DETAIL
SHOULDER AREAS

REVISIONS		
No.	DATE	DETAILS
0	JUN/06	BYLAW UPDATE
		APP. W.F.V.

REVISION
0

DRAWING No.
W-1

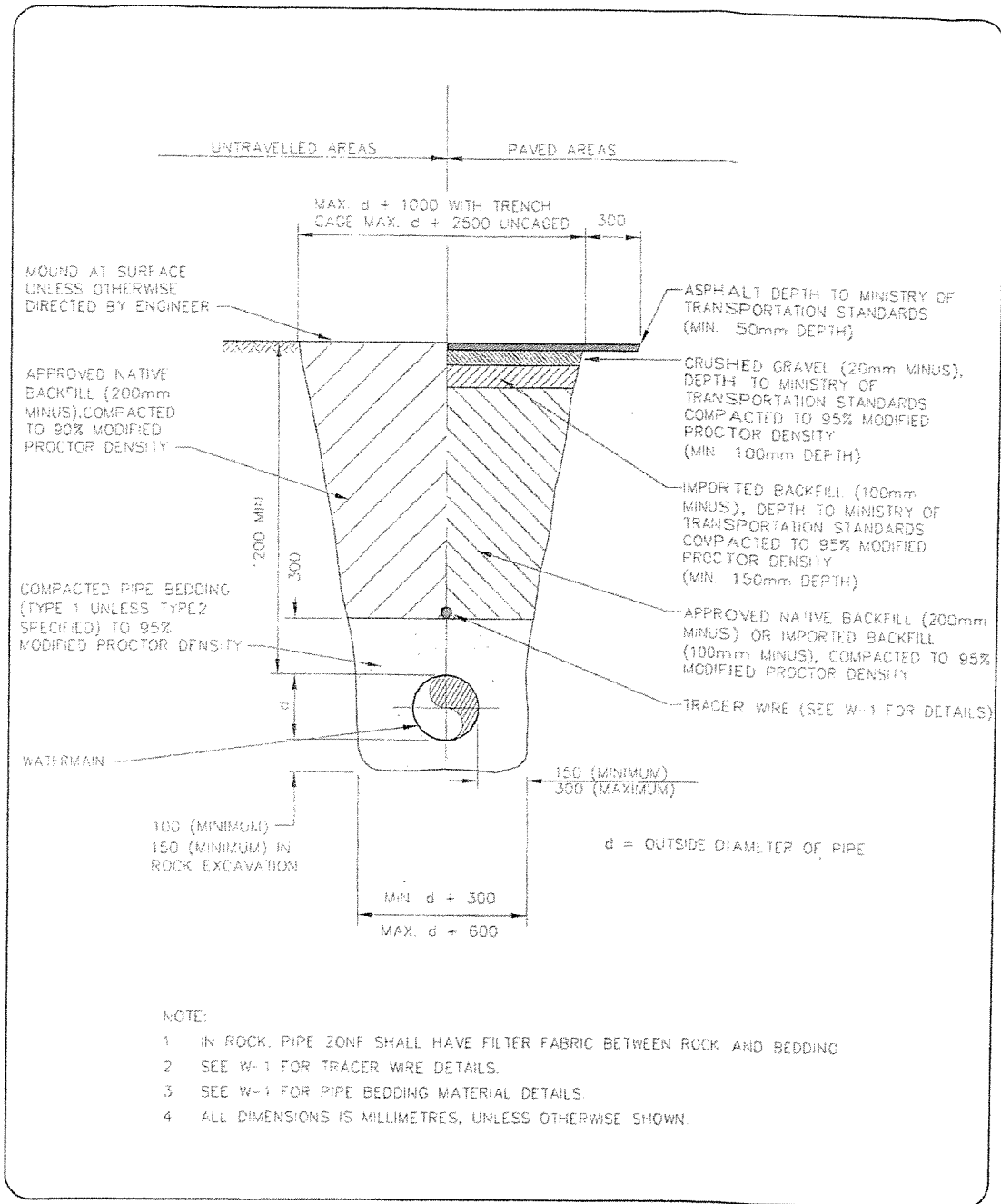

 BYLAW No. 1562
COMMUNITY WATER SYSTEM STANDARDS

**TRENCH DETAIL
PAVED & UNTRAVELLED AREAS**

REVISIONS		
No.	DATE	DETAILS
0	JUN/08	BYLAW UPDATE

APP. W.F.M.

REVISION
0

DRAWING No
W-2

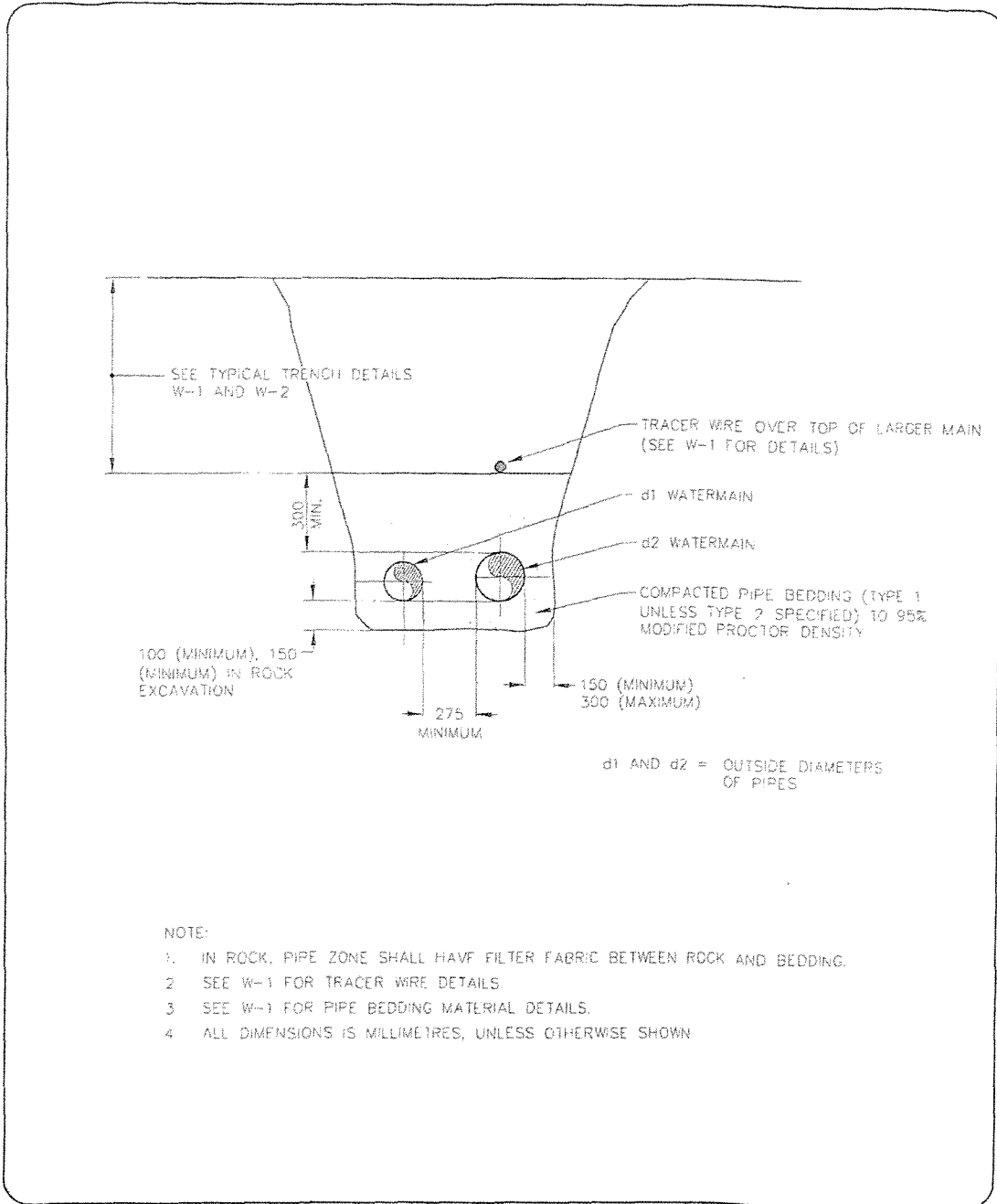

NOTE:

1. IN ROCK, PIPE ZONE SHALL HAVE FILTER FABRIC BETWEEN ROCK AND BEDDING.
2. SEE W-1 FOR TRACER WIRE DETAILS.
3. SEE W-1 FOR PIPE BEDDING MATERIAL DETAILS.
4. ALL DIMENSIONS IS MILLIMETRES, UNLESS OTHERWISE SHOWN



BYLAW No. 1562
COMMUNITY WATER SYSTEM STANDARDS

TRENCH DETAIL
TWO PIPES

REVISIONS			
No.	DATE	DETAILS	APP.
0	JUN/06	BY LAW UPDATE	W.F.M.

REVISION
0
 DRAWING No.
W-3

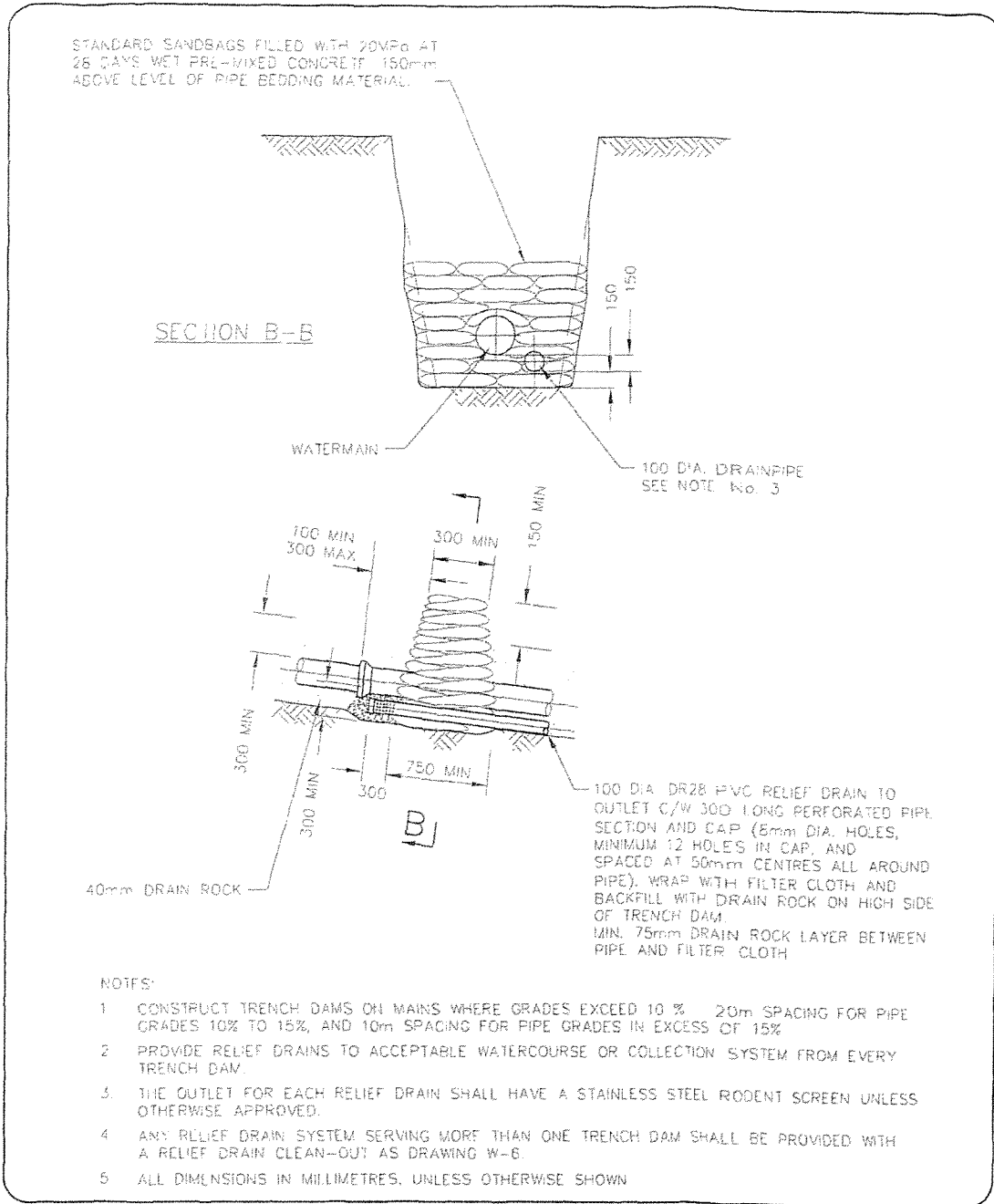

BYLAW No. 1562
COMMUNITY WATER SYSTEM STANDARDS

TRENCH DAM
SANDBAG CONCRETE TRENCH DAM

REVISIONS		
NO.	DATE	DETAILS
0	JUN/06	BYLAW UPDATE

REVISION
0

DRAWING No.
W-4

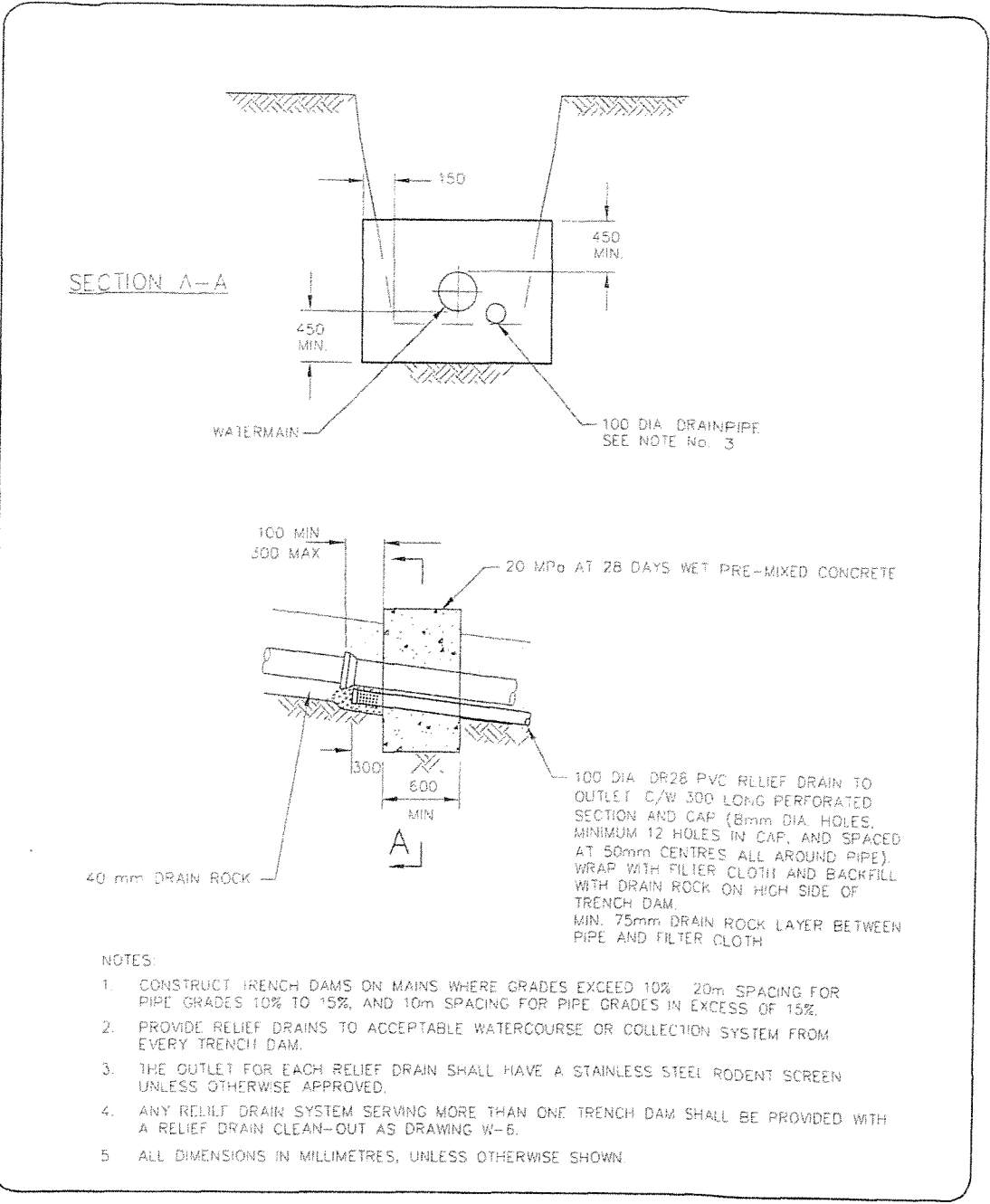

- NOTES:
1. CONSTRUCT TRENCH DAMS ON MAINS WHERE GRADES EXCEED 10% 20m SPACING FOR PIPE GRADES 10% TO 15%, AND 10m SPACING FOR PIPE GRADES IN EXCESS OF 15%.
 2. PROVIDE RELIEF DRAINS TO ACCEPTABLE WATERCOURSE OR COLLECTION SYSTEM FROM EVERY TRENCH DAM.
 3. THE OUTLET FOR EACH RELIEF DRAIN SHALL HAVE A STAINLESS STEEL RODENT SCREEN UNLESS OTHERWISE APPROVED.
 4. ANY RELIEF DRAIN SYSTEM SERVING MORE THAN ONE TRENCH DAM SHALL BE PROVIDED WITH A RELIEF DRAIN CLEAN-OUT AS DRAWING W-6.
 5. ALL DIMENSIONS IN MILLIMETRES, UNLESS OTHERWISE SHOWN



BYLAW No. 1562
COMMUNITY WATER SYSTEM STANDARDS

TRENCH DAM
FORMED CONCRETE TRENCH DAM



REVISIONS		
No.	DATE	DETAILS
0	JUN/06	BYLAW UPDATE

REVISION

0

DRAWING No

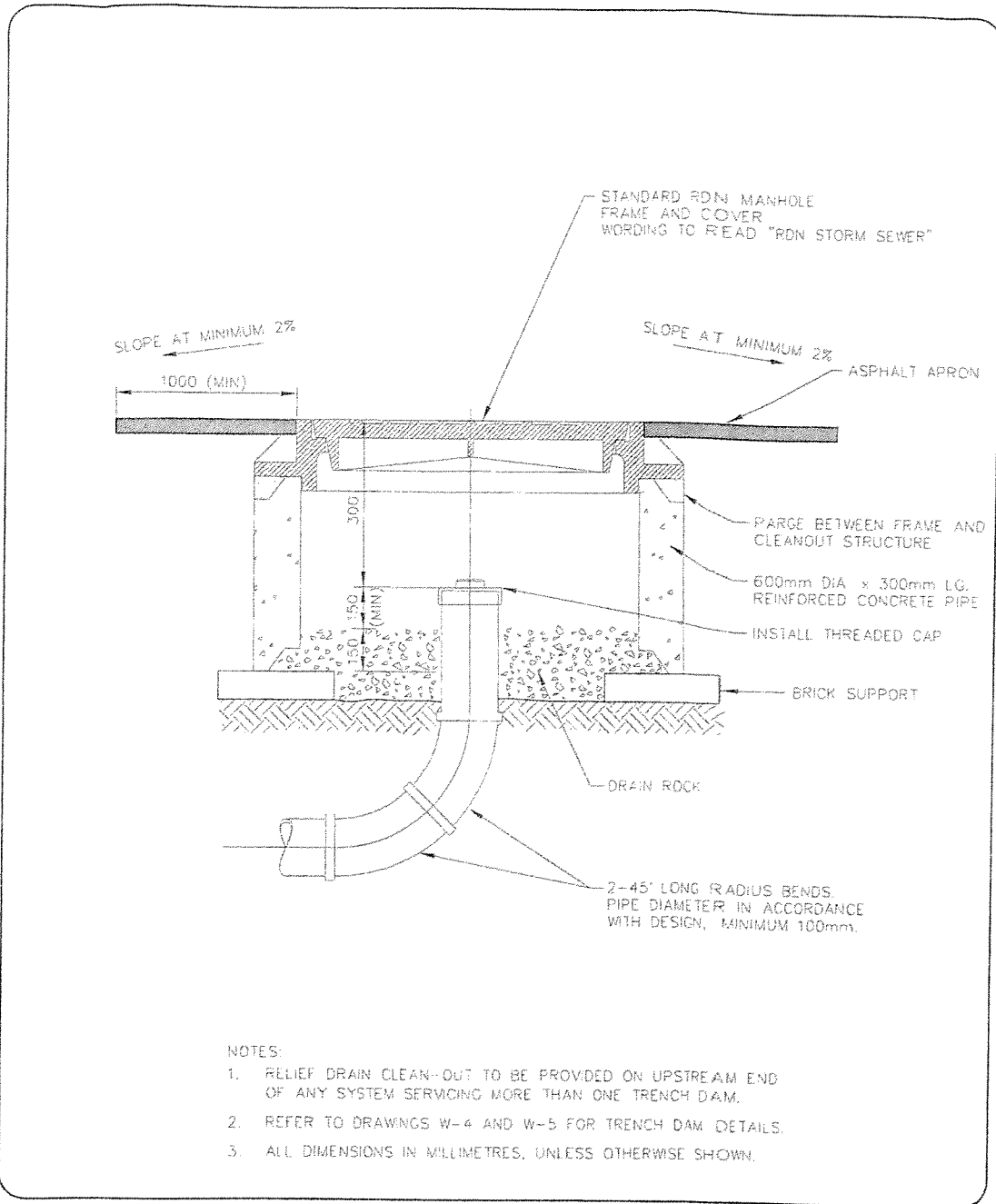
W-5





BYLAW No. 1562
COMMUNITY WATER SYSTEM STANDARDS

RELIEF DRAIN CLEANOUT

REVISIONS			
No.	DATE	DETAILS	APP. WT.M.
0	JUN/06	BYLAW UPDATE	

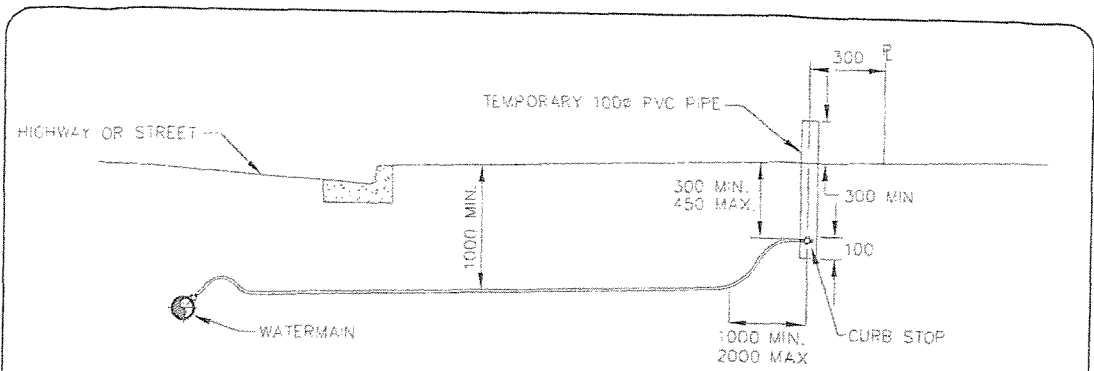
REVISION
0
DRAWING No.
W-6



NOTES:

1. PROVIDE "SLACK" IN SERVICE PIPE TO ALLOW FOR SLIGHT SUBSIDENCE.
2. MIN. 20mm SERVICE PIPE GOLDENFLOW (HDPE SERIES 160) OR 20mm SERVICE PIPE TYPE "K" COPPER FOR PIPE SPLITTING.
3. SINGLE SERVICE UP TO 25mm, DETAILS ARE SIMILAR.
4. CENTRE TO CENTRE LOCATION OF SERVICE CONNECTIONS IN THE WATERMAIN NOT LESS THAN 1m.
5. CURB STOPS COMPRESSION BY METER SWIVEL NUT
6. CONTRACTOR TO PROVIDE METER BOX TO RDN. CONCRETE BOX WITH FULL SUPPORT LIP AND STEEL LID DRILLED FOR TOUCH-READ METER PAD; LID TO READ "RDN WATER"
7. ALL DIMENSIONS IN MILLIMETRES, UNLESS OTHERWISE SHOWN

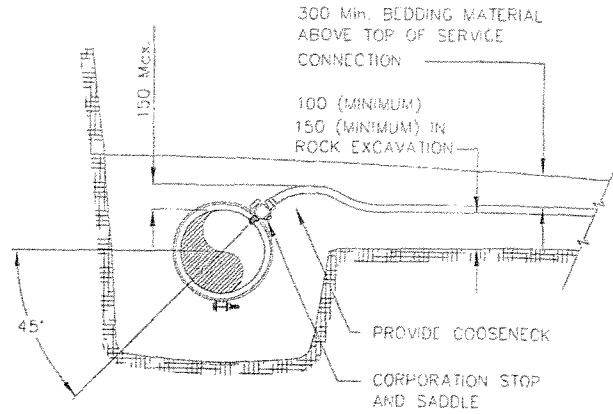



TYPE OF PIPE	LARGEST SERVICE CONNECTION ALLOWABLE	
	DIAMETER	WITH STAINLESS STEEL BAND
POLY VINYL CHLORIDE (P.V.C.)	100mm	20mm
	150mm	25mm
	200mm	40mm
	250mm	40mm
	300mm	50mm



BYLAW No. 1562
COMMUNITY WATER SYSTEM STANDARDS
WATER SERVICE CONNECTION

REVISIONS			APP. W.F.M.
No.	DATE	DETAILS	
0	JUN/06	BYLAW UPDATE	

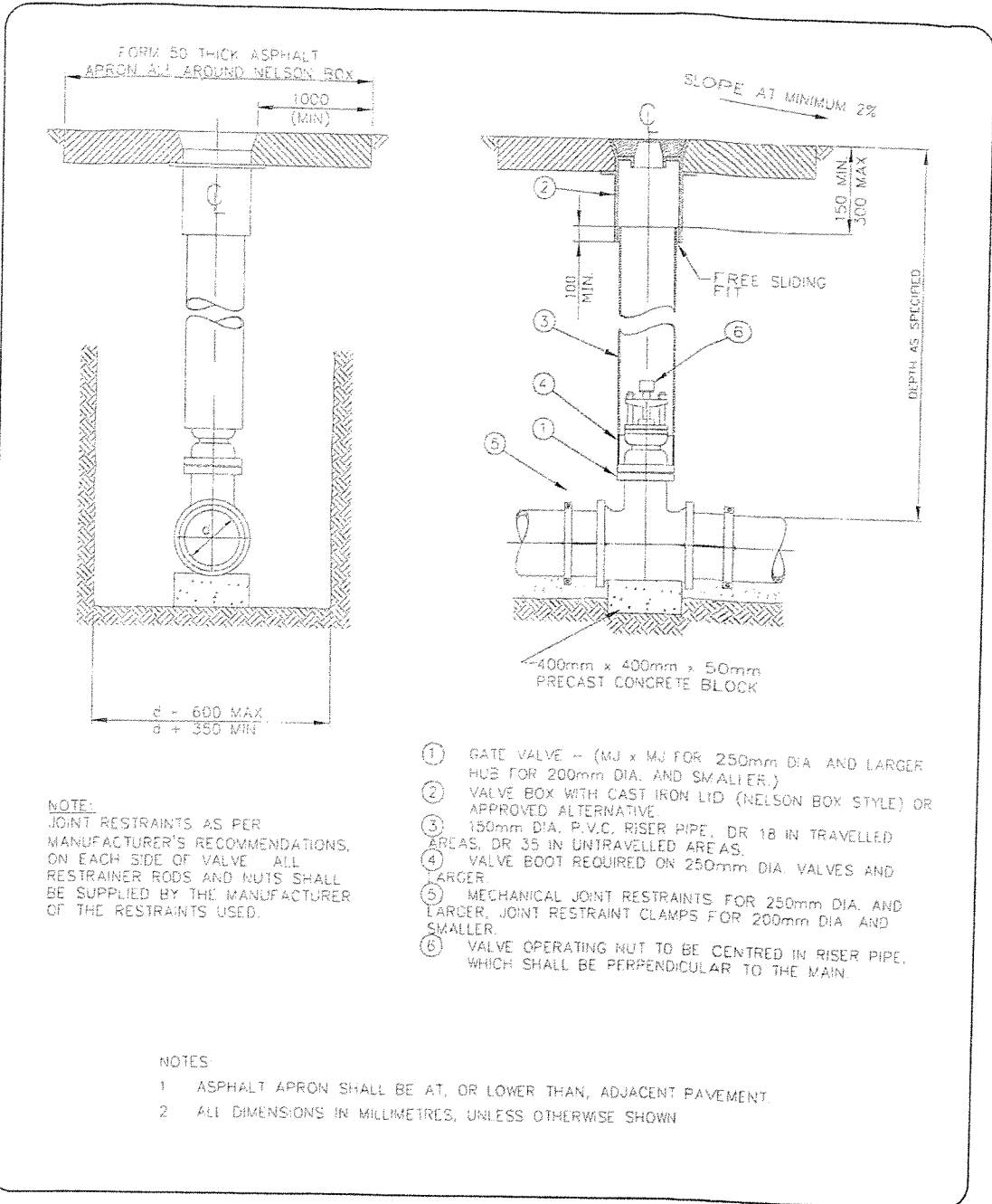
REVISION
0
DRAWING No.
W-7

BYLAW No. 1562
COMMUNITY WATER SYSTEM STANDARDS

VALVE

REVISIONS			APP.
No.	DATE	DETAILS	W.F.V.
0	JUN/06	BYLAW UPDATE	

REVISION

0

DRAWING No

W-8

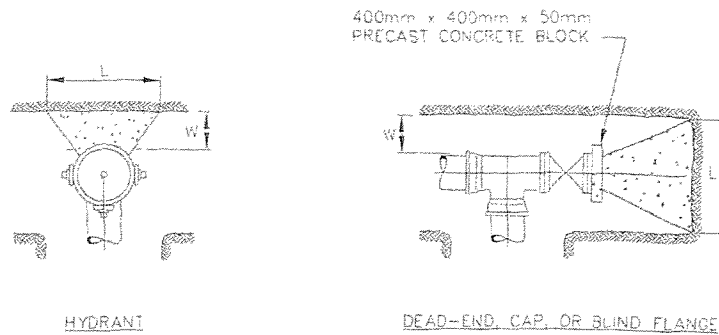

NOTE
 THRUST BLOCK MAY ONLY BE USED AT END-OF-MAIN HYDRANT. ALL OTHER HYDRANTS SHALL USE MANUFACTURED JOINT RESTRAINT CLAMPS AND MATCHING RESTRAINER RODS AND NUTS.

MINIMUM THRUST AREAS FOR FITTINGS AT 1030kN/m² PRESSURE AND FOR SOILS WITH A MINIMUM BEARING OF 96kN/m² (NOT TO BE USED FOR SOFT CLAY, MUCK, PEAT, ETC)

FITTING SIZE "D" (mm)	OUTSIDE OF FITTING TO BEARING FACE "W" (mm)	LENGTH "L" (mm)	HEIGHT "H" (mm)
150	300	600	450
200	350	750	600
250	375	975	750
300	400	1200	900
350	425	1300	1000

NOTES

1. DIMENSIONS APPLY TO THE LARGER DIAMETER END OF FITTING.
2. ALL THRUST BLOCKS TO BE CONSTRUCTED USING TRUCK DELIVERED WET PRE-MIXED CONCRETE ONLY, WITH MINIMUM 28 DAY COMPRESSIVE STRENGTH OF 20MPa.
3. WHERE GROUND CANNOT BE EXCAVATED TO FREE STANDING UNDISTURBED SOIL, UTILIZE THRUST RESTRAINT DEVICES IN PLACE OF THRUST BLOCK.
4. ALL DIMENSIONS IN MILLIMETRES, UNLESS OTHERWISE SHOWN



BYLAW No. 1562
 COMMUNITY WATER SYSTEM STANDARDS
THRUST BLOCK DETAILS

REVISIONS			APP.
No.	DATE	DETAILS	
0	JUN/06	BYLAW UPDATE	W.F.M.

REVISION
 0
 DRAWING No.
W-9

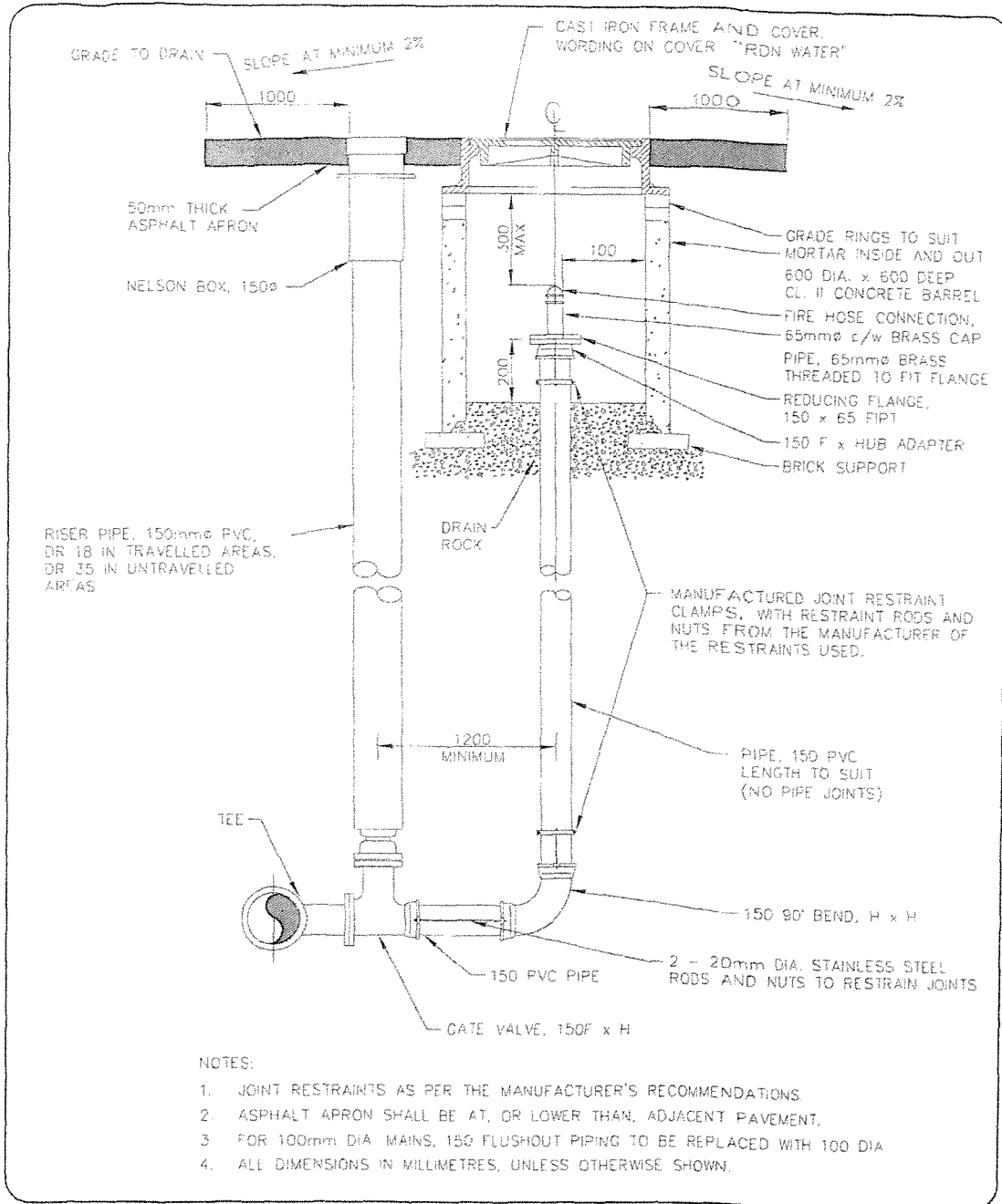

 **BYLAW No. 1562**
COMMUNITY WATER SYSTEM STANDARDS
BELOW GROUND FLUSHOUT

REVISIONS		
No.	DATE	DETAILS
0	JUN/08	BYLAW UPDATE
		APP. W.F.M.

REVISION
0
DRAWING No
W-10

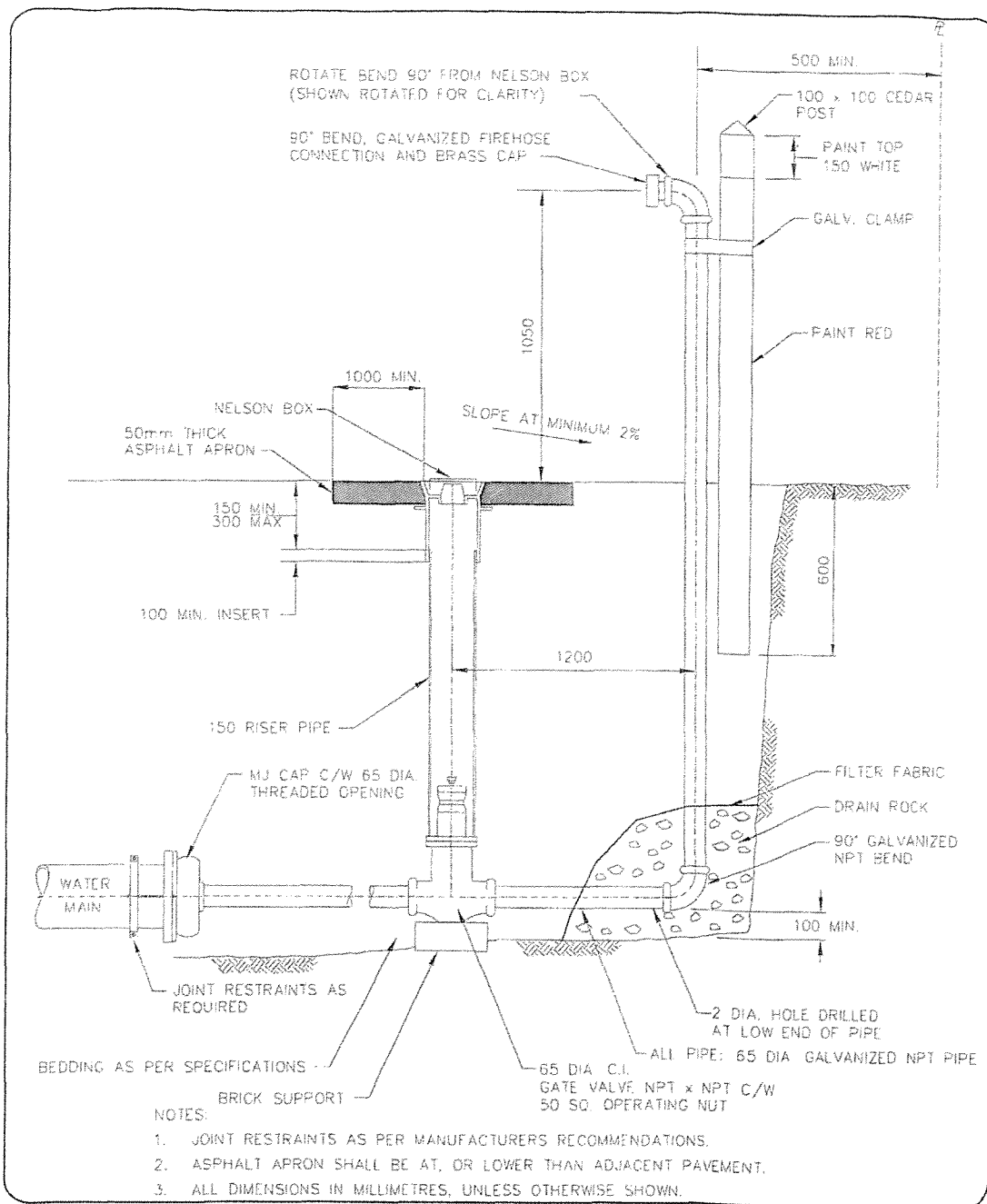

 **BYLAW No. 1562**
COMMUNITY WATER SYSTEM STANDARDS

TEMPORARY
ABOVE GROUND FLUSHOUT

REVISIONS		
No.	DATE	DETAILS
0	JUN/06	BYLAW UPDATE

APP. W.F.M.

REVISION
0

DRAWING No.
W-11

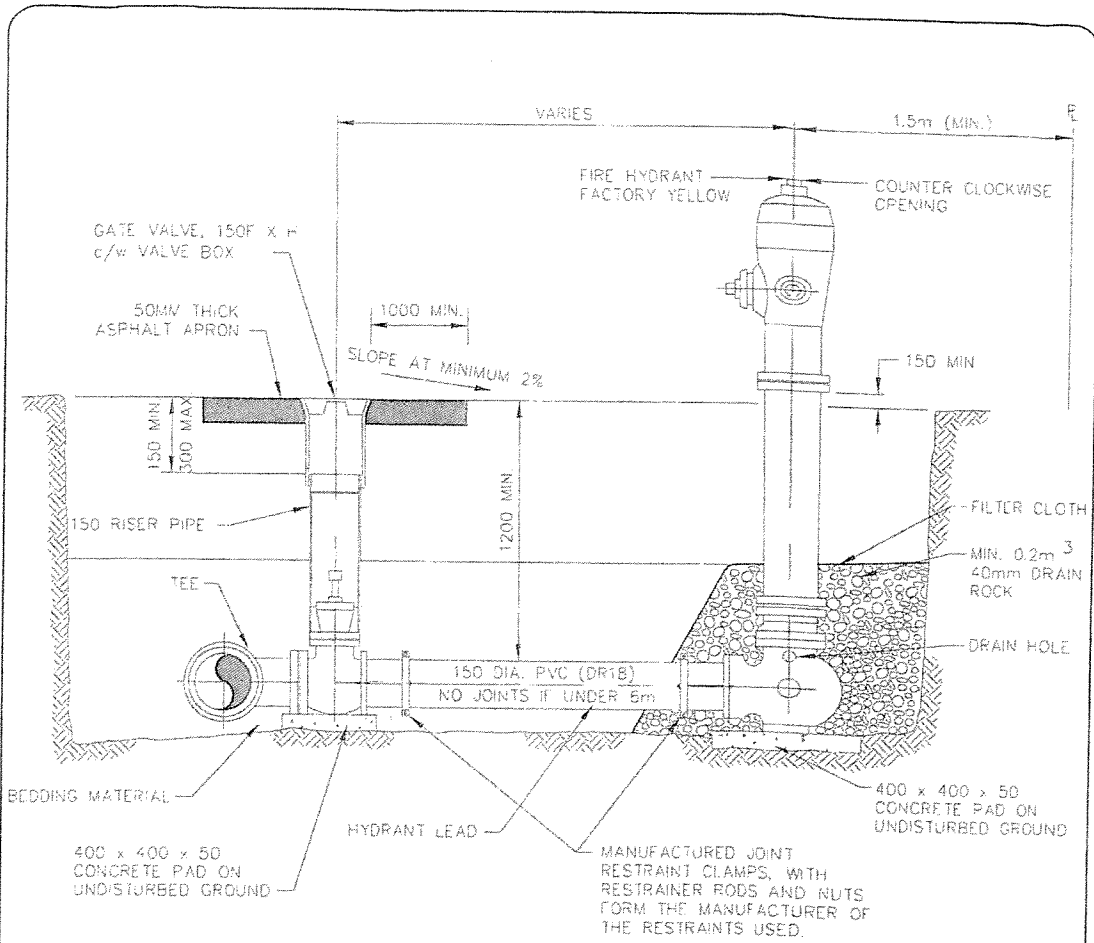

NOTES:

1. PUMPER NOZZLE PERPENDICULAR TO ROAD CENTRELINE.
2. HYDRANT TO BE INSTALLED VERTICAL.
3. MANUFACTURED JOINT RESTRAINERS TO BE USED AT EVERY PIPE JOINT FOR HYDRANT LEADS OVER 6m IN LENGTH. RESTRAINTS REQUIRED AT HYDRANT BOOT AND VALVE FOR LEADS 2m TO 6m LONG. LEADS LESS THAN 2m MAY BE RESTRAINED USING 2-20mm DIA. STAINLESS STEEL THREADED RODS c/w SS NUTS AND SS WASHERS.
4. END-OR-MAIN HYDRANT SHALL BE FULLY RESTRAINED AS PER MANUFACTURER'S RECOMMENDATIONS, OR MAY USE A THRUST BLOCK (SEE W-9 FOR DETAILS).
5. ASPHALT APRON SHALL BE AT, OR LOWER THAN, ADJACENT PAVEMENT.
6. WHERE CURB/GUTTER DOES NOT EXIST, PAVE FROM EDGE OF ROAD SURFACE TO 1m BEHIND HYDRANT AND 2m WIDE.
7. ALL DIMENSIONS IN MILLIMETRES, UNLESS OTHERWISE SHOWN.





BYLAW No. 1562
COMMUNITY WATER SYSTEM STANDARDS
FIRE HYDRANT ASSEMBLY

REVISIONS			APP.
NO.	DATE	DETAILS	
0	JUN/06	BYLAW UPDATE	W.F.M.

REVISION
0

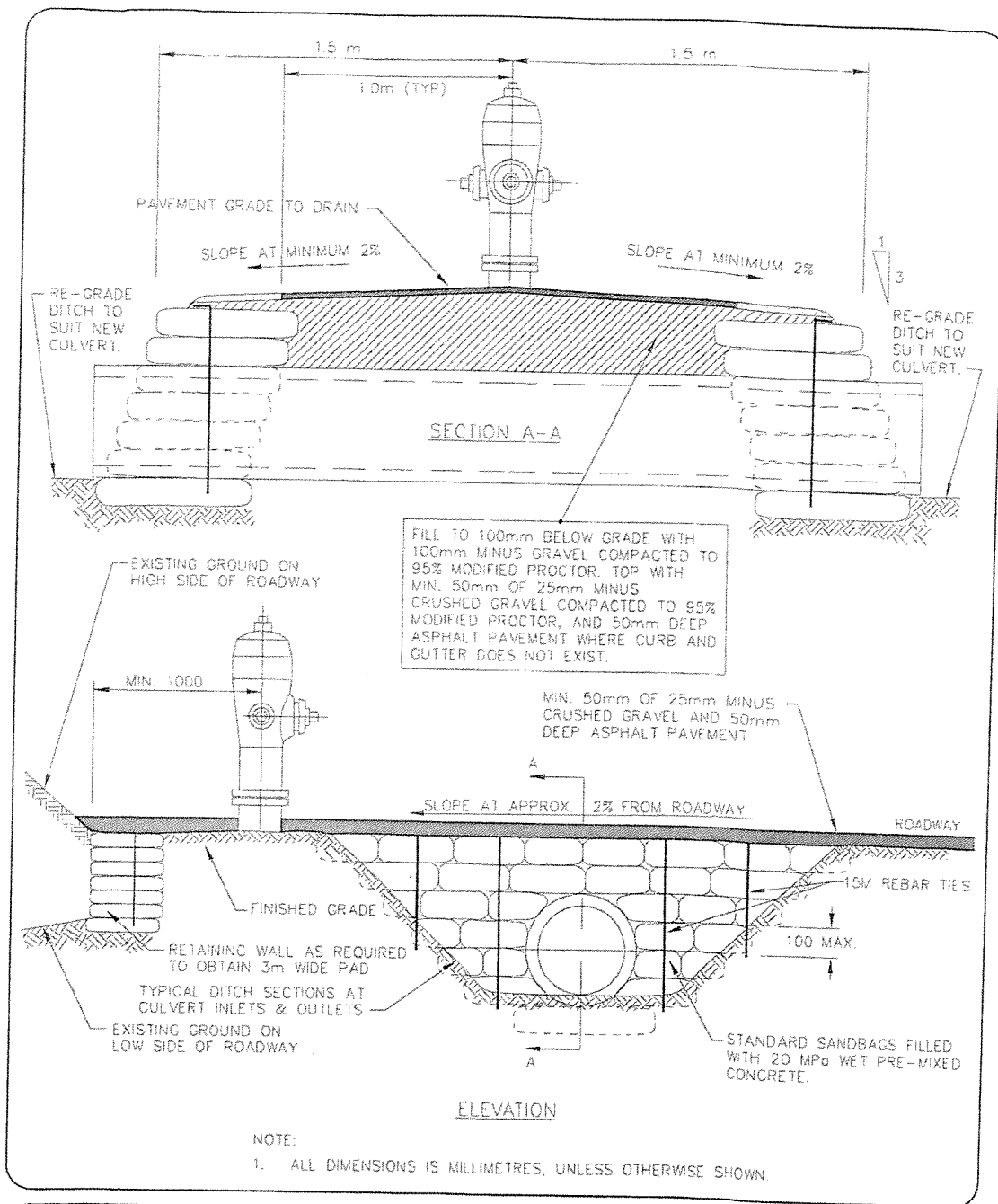
DRAWING No
W-12

BYLAW No. 1562
COMMUNITY WATER SYSTEM STANDARDS

HYDRANT ACCESS CULVERT

REGIONAL DISTRICT OF NANAIMO

REVISIONS		
No.	DATE	DETAILS
0	JUN/06	BYLAW UPDATE

APP. W.F.M.

REVISION
0
DRAWING No
W-13

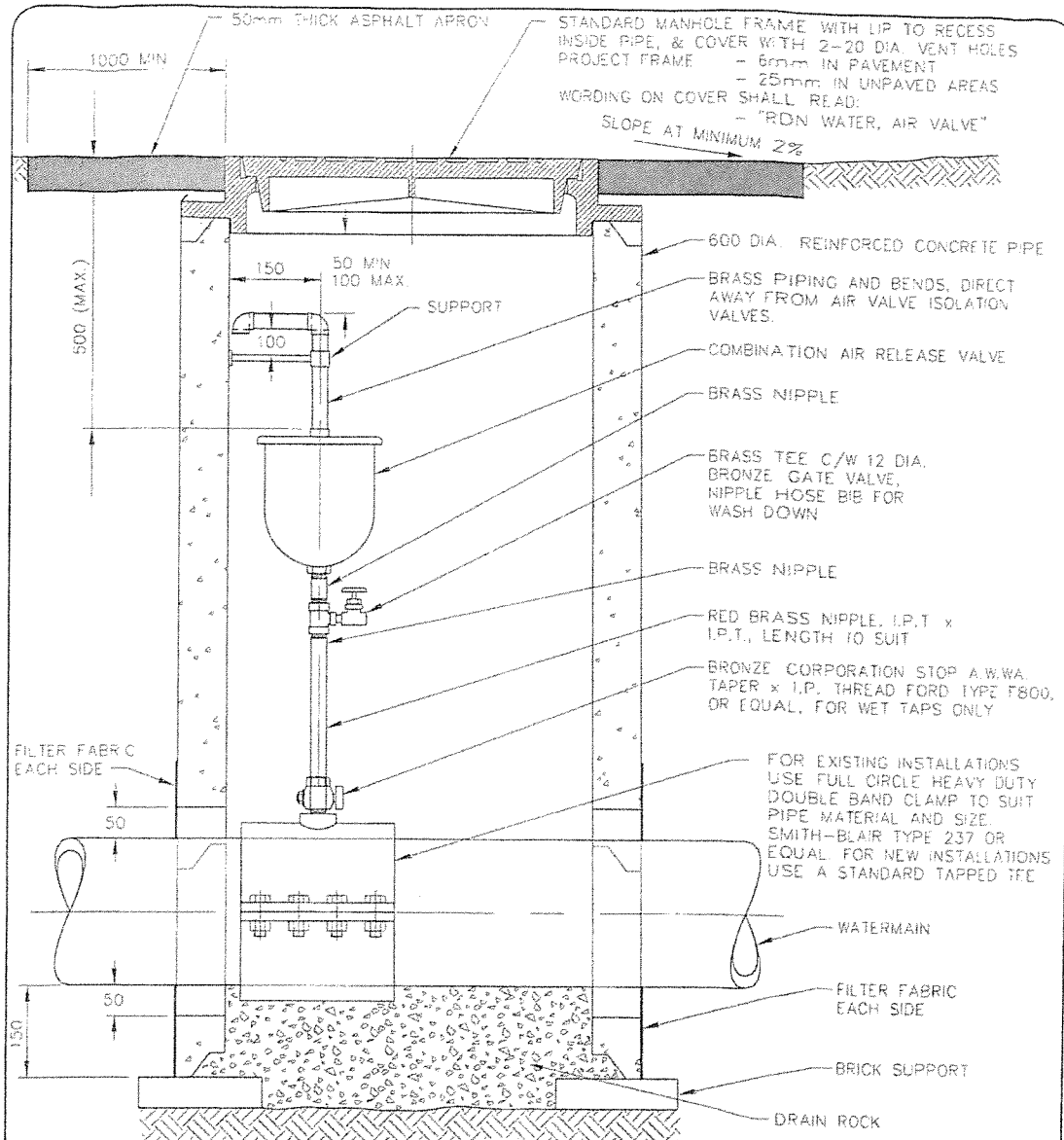

NOTES:

1. IN AREAS WHERE HIGH WATER TABLE MAY APPROACH AIR VALVE VENT OUTLET, CHAMBER DRAINAGE TO BELOW AIR VALVE SHALL BE PROVIDED. IF NOT FEASIBLE, VENT PIPE SHALL BE EXTENDED OUTSIDE CHAMBER, INSIDE A GALVANIZED VENT PIPE (SEE W-15 FOR VENT DETAILS).
2. ASPHALT APRON TO BE AT, OR LOWER THAN, ADJACENT PAVEMENT
3. ALL DIMENSIONS IN MILLIMETRES, UNLESS OTHERWISE SHOWN.



BYLAW No. 1562
COMMUNITY WATER SYSTEM STANDARDS
AIR VALVES UP TO 50mm DIAMETER

REVISIONS		
No.	DATE	DETAILS
0	JUN/06	BYLAW UPDATE

REVISION	0
DRAWING No	W-14

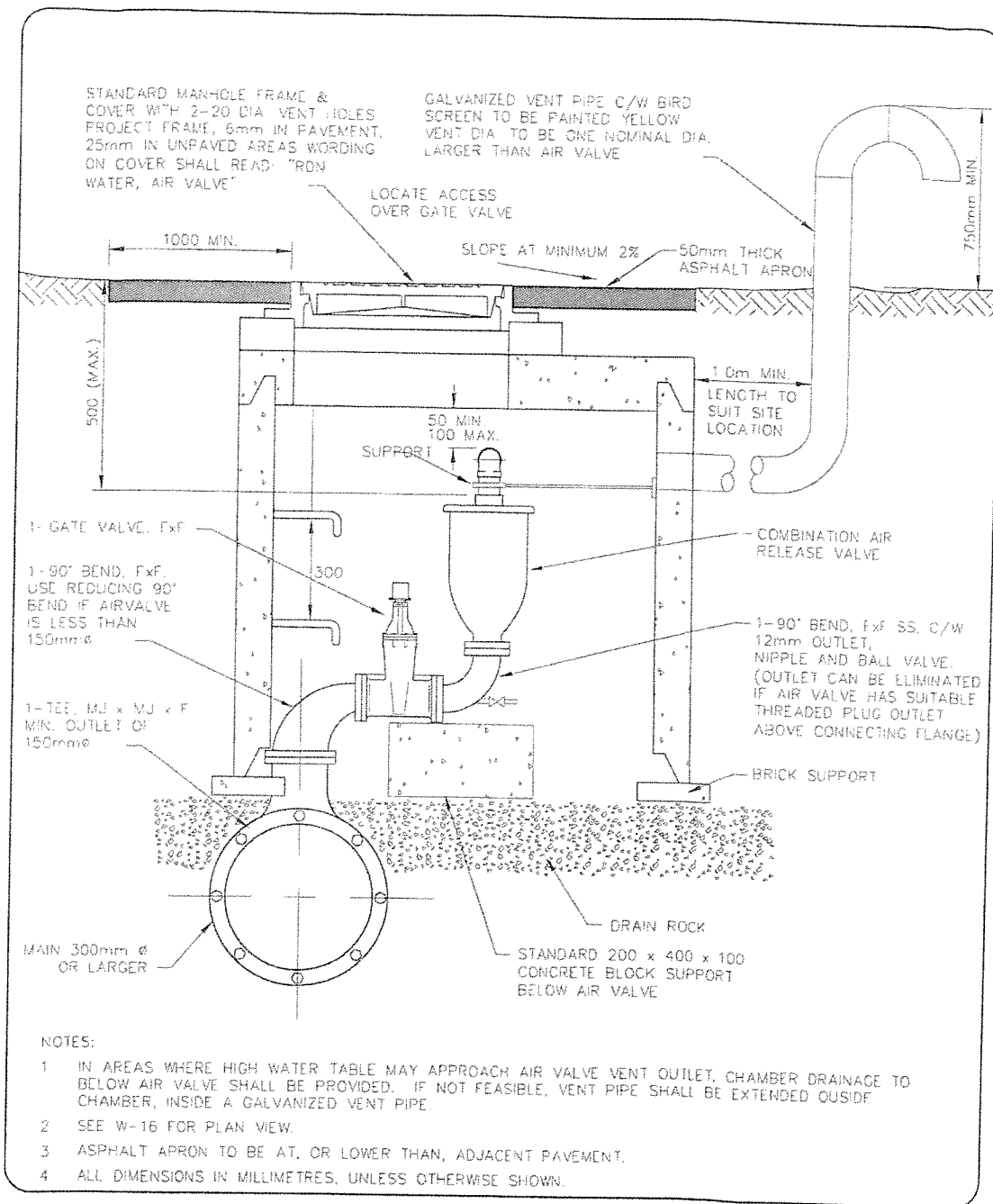

 **BYLAW No. 1562**
COMMUNITY WATER SYSTEM STANDARDS
AIR VALVE 75mm DIA. AND LARGER
SECTION

REVISIONS			
No.	DATE	DETAILS	APP. I/W.F.M.
0	JUN/06	BYLAW UPDATE	

REVISION
0
DRAWING No.
W-15

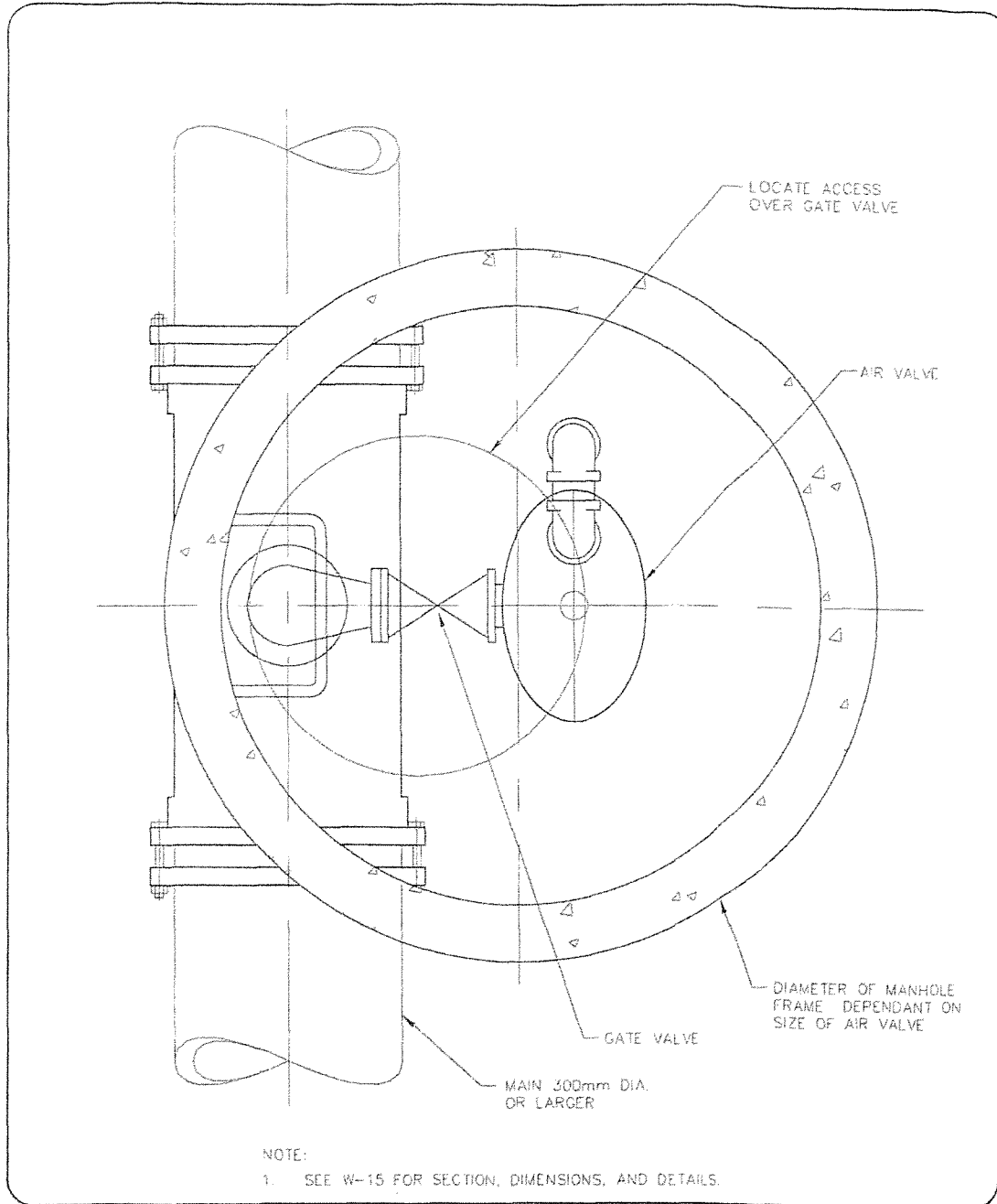

 **BYLAW No. 1562**
COMMUNITY WATER SYSTEM STANDARDS

AIR VALVE 75mm DIA. AND LARGER
PLAN

REVISIONS			APP.
No.	DATE	DETAILS	W.F.M.
0	JUN/06	BYLAW UPDATE	

REVISION
0

DRAWING No
W-16

**REGIONAL DISTRICT OF NANAIMO
BYLAW NO. 500**

SCHEDULE '7D'

COMMUNITY WATER SYSTEM STANDARDS

APPENDIX 3

APPROVED PRODUCTS LIST

Regional District of Nanaimo - Approved Products List - Public Water Systems

Section	Product	Manufacturer	Model	Size	Comments
2.8	Pipe - Ductile Iron	Canada Pipe Canron Stanton			
2.8	Pipe - PVC	Diamond Flexlox Ipex Northern Pipe Rehau	C900	4"-12"	Pipes to meet colour requirements of RDN
2.9	Ball Valve	Kits Red and White			
2.9	Detector Check Valve	Ames Febco Hersey Kennedy Watts Industries	10000CV 800DC EDC III B2 Series 07F	6"-10" 6"-10" 6"-10" 6"-10" 6"-10"	UL/FM UL/FM UL/FM UL/FM UL/FM
2.9	Bronze Compression Fittings	A.Y. McDonald Cambridge Brass Ford Jones Mueller	Q-Series Only H-Series Only Q-Fittings Only SG Fittings Only H-Series Only	3/4"-2" 3/4"-2"	Full Flow Only Full Flow Only Full Flow Only Full Flow Only Full Flow Only
2.9	Curb Stop	A.Y. McDonald Cambridge Brass Ford Jones Mueller	Q-Series Only H-Series Only Q-Fittings Only SG Fittings Only H-Series Only	3/4"-2" 3/4"-2"	Full Flow Only Full Flow Only Full Flow Only Full Flow Only Full Flow Only
2.9	Meter Box (Plastic)	Ametek-Plymouth Ametek-Plymouth Ametek-Plymouth Brooks Products	10-170-003 (extension) 10-171-001 (cover) 10-170-001 (box) 37	300x500 300x500 300x500 300x500	Only for use where approved Only for use where approved Only for use where approved
2.9	Pipe Saddles (For DI)	Robar Romac (Rockwell) Smith-Blair	STYLE 313	4"-12" 4"-12" 4"-12"	

Section	Product	Manufacturer	Model	Size	Comments
2.9	Pipe Saddles (For PVC)	Canpac Mueller Robar Rockwell		4"-12" 4"-12" 4"-12" 4"-12"	
2.9	Service Pipe - Copper	Cerro Wolverine Tube	Type K Soft Type K Soft		
2.9	Water Meters	Schlumberger (Neptune) Sensus		5/8"-3/4"	Domestic DIRECT READ Meters Only
2.9	Pipe - Copper	(None Listed)			
2.9	Service Box (Concrete)	Brooks Products Brooks Products	37 66	300x500 425x750	
2.10	Hydrants	AVK Mueller	2780 Super Centurion 250		See below for Paint Colour See below for Paint Colour
2.11	Valves - Butterfly	Dezuirk Pratt Pratt	AWWA HP250 (250 PSI) Groundhog (150 PSI)	4"-12" 4"-12" 4"-12"	Complete with LA-Series operator
2.11	Valves - Gate	Mueller Jenkins	A-2380 Bronze Seat	2"-12" 2"-12"	
2.11	Valves - Resilient Wedge	AVK Clow Mueller	Series 25 Model 2630 A-2360	2"-12" 4"-12" 4"-12"	Stainless Steel Stem UL/FM UL/FM
2.11	Valves - Box	Alfs Castings Terminal City Terminal City	D7 (Nelson Type) Nelson Type MR Style (Robar)		For use outside of paved areas For use outside of paved areas Paved Areas c/w Parsons Lid
2.11	Air Valves	Apco Crispin GA Industries Terminal City Valmatic	143-C 945 201C		
2.12	Repair Coupling	Robar Rockwell Romac Smith-Blair		4"-12" 4"-12" 4"-12" 4"-12"	

Section	Product	Manufacturer	Model	Size	Comments
2.12 2.12	Silent Check Valve Pressure Reducing Valves	Valmatic Clayton Valve (CLA- VAL CO.) Singer Valve		4"-12" 4"-12"	
2.12	Fittings - Cast Iron	Metalfit Norwood Foundary Sigma Corporation Terminal City		4"-12" 4"-12" 4"-12" 4"-12"	Cement mortar lined only. Cement mortar lined only. Cement mortar lined only. Cement mortar lined only.
2.12	Fittings - Ductile Iron	Bibby/Acs Sigma Corporation Terminal City		4"-12" 4"-12" 4"-12"	Imported fittings-CHINA A-1 only
2.12	Pressure Gauges	Ametek - Plymouth Clayton Marsh			
2.12	Strainers	BCA			Approvals on a per project basis.
2.12	Flange Adaptor	EBAA Iron EBAA Iron EBAA Iron Uni-Flange	Series 2100 Megaflange Megaflange Series 1000 E-Z flange Series 400	3"-12" 3"-10" 3"-10" 3"-8"	Ductile iron pipe only (UL) Ductile iron pipe only (UL/FM) Ductile iron pipe only (UL/FM) Ductile iron pipe only (FM)
2.12	Repair Clamps	Mueller Romac	530 SS2	4"-12" 4"-12"	Two Section Clamp Two Section Clamp
2.12	Thrust Restraint - Ductile Iron (Wedge-Action)	EBAA Iron Sigma Uni-Flange Uni-Flange	Series 1100 Mega-Lug One Lok Series 1300C Series 1400D/1450D	3"-12" 4"-12" 4"-12" 4"-12"	Ductile Iron Pipe (UL/FM) Ductile Iron Pipe (UL/FM) Ductile Iron Pipe (UL/FM) Ductile Iron Pipe (UL/FM)
2.12	Thrust Restraint (PVC)	EBAA Iron EBAA Iron EBAA Iron Romac Sigma Uni-Flange Uni-Flange Uni-Flange	Series 2000 Series 1500PF Series 1600 600 Series PV - Lok; PVP Series Series 1350 Series 1390 Series 1300		For Class 150 PVC pipe (UL/FM) For Class 150 PVC pipe (FM) For Class 150 PVC pipe (FM) PVC (UM/FM) PVC Pipe (FM) For Class 150 PVC pipe (FM) For Class 150 or 200 PVC pipe only (FM) For Class 150 or 200 PVC pipe only (FM)

Section	Product	Manufacturer	Model	Size	Comments
2.12	Sump Drainer	BCA	A174		
2.12	Manhole Cover and Frames - Heavy Duty	Alfs Castings Dobney Foundary TR Castings	C18 C18		
2.12	Manhole Cover and Frames - Utility Chamber	Alfs Castings Dobney Foundary Sigma Corporation TR Castings	C-22 C-22		
3.4	Concrete	Bedrock Concrete Mayco-Mix Ocean Construction			
3.5	Gravel - Bedding Type 2	Hub City Paving Lussier and Son			
3.5	Gravel - Base	Haylock Bros. Paving Ltd Hazelwood Construction Hub City Paving Lussier and Son	Alberni Highway Pit Timberlands Pit	25mm	Blended with Rap <10%
3.5	Manhole Sections	Lombard Precast Ocean Construction			
3.5	Manhole Steps	Lombard Precast Ocean Construction			
3.5	Manhole Tops	Lombard Precast Ocean Construction			
3.6	Gravel - Imported Granular	Hub City Paving Lussier and Son			
3.6	Concrete - Controlled Density Fill	Bedrock Concrete			

**REGIONAL DISTRICT OF NANAIMO
BYLAW NO. 500**

SCHEDULE '7D'

COMMUNITY WATER SYSTEM STANDARDS

APPENDIX 4

LETTER OF ASSURANCE

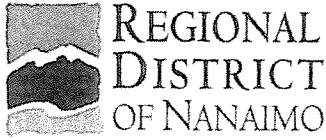

LETTER OF ASSURANCE

NOTE:

To be submitted at time of Feasibility Review

To: Manager of Engineering Services
Regional District of Nanaimo
6300 Hammond Bay Road
Nanaimo BC V9T 6N2

RE: _____
(Project)

Date: _____, 20__.

This will confirm that (Developer _____) has retained (Consultant _____) to provide, design, contract administration, inspection and as-constructed drawings for this project all in accordance with the current bylaws and standards of the Regional District and in accordance with good engineering practice.

(Developer)

This confirms we have accepted this assignment on the above terms.

(Consultant)

Initial	Initial
---------	---------

**REGIONAL DISTRICT OF NANAIMO
BYLAW NO. 500**

SCHEDULE '7D'

COMMUNITY WATER SYSTEM STANDARDS

APPENDIX 5

CERTIFICATE OF DESIGN

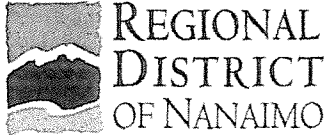

CERTIFICATE OF DESIGN

I, _____, a Professional Engineer registered in the Province of British Columbia, hereby certify that the works as herein set out on the attached drawings entitled _____

_____ have been designed in accordance with the Regional District of Nanaimo Bylaw 500 and/or in accordance with good engineering practice where such design is not covered by the Regional District Bylaw 500.

I have been retained to provide design, supervision, full-time inspection, as-built drawings, and final certification for this project by:

(Name of Client)

I am satisfied that in the contractual mandate which exists between myself and my client, the terms of reference will permit me to render a level of supervision of the construction work which will allow me to put my name and seal to the "Certification of Installed Works" required by the Regional District of Nanaimo, a sample of which is attached to this document and initialed by me.

In the event that my client releases me from this project, or in the event that I find the terms of reference do not permit me to render a level of supervision of the construction work which will allow me to put my name and seal to the form of certification required by the Regional District of Nanaimo, I will notify the Regional District within twenty-four (24) hours verbally and follow it up with written confirmation and clarification.

Signed this _____ day of _____, 20____.

_____, P.Eng.
(signature)

(name printed)

I understand that the "Certification of Installed Works" is to be completed in this format and submitted with the "as-constructed" drawings.

(Engineer)

Initial	Initial
---------	---------

**REGIONAL DISTRICT OF NANAIMO
BYLAW NO. 500**

SCHEDULE '7D'

COMMUNITY WATER SYSTEM STANDARDS

APPENDIX 6

CERTIFICATION OF INSTALLED WORKS

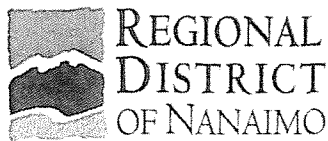

CERTIFICATION OF INSTALLED WORKS

NOTE: To be completed in this format and submitted with the 'As-Built' drawings

Location of the Construction Site and Works: (Legal Description / Location)

all within the Regional District of Nanaimo, British Columbia.

I, _____, a Registered Professional Engineer (Reg. No. _____) in the Province of British Columbia, hereby certify:

1. THAT the following construction tests were carried out to confirm that construction met the specifications required:
 - a) _____
 - b) _____
 - c) _____
 - d) _____
 - e) _____
 - f) _____

2. THAT I was able to monitor the construction and provide a level of supervision of the construction work sufficient to be able to confirm that the specifications in force and effect by the Regional District of Nanaimo and in the applicable design drawings for the said Works were generally met during the Construction Period; and

3. THAT the accompanying plans labeled:
 - (i) _____
 - (ii) _____
 - (iii) _____

accurately record the materials, grades, inverts, offsets and dimensions of the constructed work.

DATED this _____ day of _____, 20 ____.

Engineer (signature & seal)

Engineering Firm

Initial	Initial
---------	---------

**REGIONAL DISTRICT OF NANAIMO
BYLAW NO. 500**

SCHEDULE '7D'

COMMUNITY WATER SYSTEM STANDARDS

APPENDIX 7

FIRE HYDRANT USE PERMIT

FIRE HYDRANT USE PERMITTING (See Application Form following)

1. Applications for a connection are to be made using the “Fire Hydrant Use Permit” Application form included as part of this schedule.
2. Fire Hydrant use will be approved at the sole discretion of the RDN Manager of Utilities.
3. Fire Hydrant use permits will only be considered for works or activities being carried out within the permit application Water Service Area.
4. Fire Hydrant Use will not be granted for the purposes of water resale.
5. Fire Hydrant connections and disconnections will be made by RDN staff only.
6. Regional District of Nanaimo Staff will determine the allowable flow rate for each permitted use.
7. The Regional District of Nanaimo retains the right to disconnect any connection at any time.

Initial	Initial
---------	---------

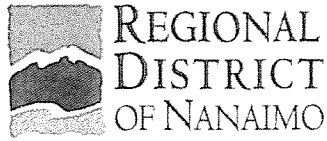

FIRE HYDRANT USE PERMIT APPLICATION FORM

APPLICANT'S NAME: _____

MAILING ADDRESS: _____ Postal Code _____

TELEPHONE: _____ CELL: _____ FAX: _____ EMAIL: _____

- This application is for use of the fire hydrant located at _____
- Anticipated for the period _____ to _____
- For the following uses: _____
- Project Description: _____
- RDN Water Service Area: _____

I understand and agree to the following:

- Application fee is \$50.00
- Fire hydrant use fee/deposit in the amount of \$500.00.
- The fire hydrant may not be used until this Permit has been issued and the RDN staff have installed backflow prevention devices.
- Fire hydrant use is restricted to only the above-noted uses that have been accepted by the Manager.
- The Applicant may not leave the hydrant and associated equipment unattended.
- The permit may be revoked by the RDN at any time, where deemed necessary.
- On completion the RDN will inspect and maintain the hydrant as required, deduct a \$125 fee, any repair costs and water consumption fees from the \$500 deposit, and refund/invoice the balance to the Applicant.

SIGNATURE OF APPLICANT: _____ DATE: _____

Personal information collected on this form is collected for the purpose of processing this application and for administration and enforcement. The personal information is collected under the authority of the *Local Government Act* and RDN bylaws. If you have any questions about this collection, contact the Manager of Utilities at 6300 Hammond Bay Road in Nanaimo or by phone at 390-6560. Personal information or business information submitted on this form is not considered to be supplied in confidence. Applicant's initials _____

Utilities Department Use Only Below This Line

Permit Approved Permit Denied for the following reasons: _____

_____ Date: _____ Hydrant # _____ Permit # _____

Manager of Utilities

Application Fee (a) \$50.00 (11-__-__-98-00)

Damage Deposit (b) \$500.00 (14-35-00-00-00)

Refund equals the Damage Deposit less,

Less RDN inspection/maintenance fee (\$125) (c) \$125.00 (11-__-__-98-00)

Less costs for any damages (d) \$ _____

Less water consumption at \$2.00/meter cubed

Consumption m³ _____ x \$2.00 = (e) \$ _____

Amount to refund or invoice (b minus c+d+e) \$ _____ (11-__-__-98-00)

Refund/Invoicing Approved by Manager of Utilities _____ Date: _____

Initial	Initial
---------	---------

**REGIONAL DISTRICT OF NANAIMO
BYLAW NO. 500**

SCHEDULE '7D'

COMMUNITY WATER SYSTEM STANDARDS

APPENDIX 8

HYDRANT CERTIFICATION FORM

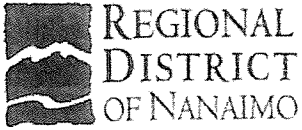

FIRE HYDRANT CERTIFICATION FORM

Hydrant Number: _____ Installation Date: _____ Area: _____

Hydrant Location: _____

Supplier: _____ Manufacturer: _____ Model: _____

Depth of bury: _____ Extension length (if applicable): _____

Isolation Valve Location: _____

Hydrant Colour: _____ System PSI: _____

- Visible from street: Check = Yes
- Easily accessible: Check = Yes
- Obstructions: Check = No
- Visible leakage: Check = No
- Opens smooth: Check = Yes Number of turns: _____
- Drains properly: Check = Yes
- Paint OK: Check = Yes

Port Diameters:

- Hose Nozzle: 77 mm (OD) 8 threads per 25 mm. Check = Yes
- Pumper Nozzle: 117.5 mm (OD) 6 threads per 25 mm. Check = Yes

Contractor: _____

Comments:

Inspected by: _____ Date: _____

Initial	Initial
---------	---------

REGIONAL DISTRICT OF NANAIMO
BYLAW NO. 500

SCHEDULE '7D'

COMMUNITY WATER SYSTEM STANDARDS

APPENDIX 9

TRANSFER AGREEMENT

REGIONAL DISTRICT OF NANAIMO
WATER/SEWER/STREETLIGHTING TRANSFER AGREEMENT
(List the Name of Subdivision or Development here)

THIS AGREEMENT made the ____ day of _____, 20__
(hereinafter called the "Agreement")

BETWEEN:

REGIONAL DISTRICT OF NANAIMO
6300 Hammond Bay Road
Nanaimo BC
V9T 6N2

(hereinafter called the "Regional District")

OF THE FIRST PART

AND

(hereinafter called the "Developer")

OF THE SECOND PART

WHEREAS:

A. The Developer constructed and owns a water/sewer/streetlighting system servicing those parcels or tracts of lands and premises situate in the Regional District of Nanaimo, in the Province of British Columbia, being more particularly know and described as:

(Legal Description)

(the "Water/Sewer/Streetlighting System")

B. The RDN may, by bylaw and pursuant to subsections 796 (b) of the Local Government Act, establish and operate a service for the collection, conveyance and disposal of sewage and the supply, conveyance, storage and distribution of water;

C. The RDN has the right, under subsection 176(1) of the Local Government Act to acquire real and personal property for the purposes of a service provided by the RDN;

D. The developer has agreed to transfer to the RDN the Works on the terms and conditions hereinafter appearing.

NOW THEREFORE THIS AGREEMENT WITNESSES that in consideration of the sum of **ONE DOLLAR (\$1.00)** and other valuable consideration, the receipt and sufficiency of which is hereby acknowledged, the RDN and The Developer covenant and agree as follows:

Initial	Initial
---------	---------

1. **INTERPRETATION**

In this Agreement,

“Works” means that system of water/sewer/streetlighting works and all appurtenant pipes, conduits, lamps, fittings, valves and meters installed and constructed by the Developer and employed by or in connection with the Water/Sewer/Streetlighting System, and more particularly described in Appendix “A” to this Agreement.

2. **COMPLETION DATE**

The Completion Date shall be _____.

3. **TRANSFER OF INTEREST**

As of the Completion Date, The Developer hereby sells, assigns and transfers to the RDN all of its rights, title and interest in the Works.

4. **REPRESENTATIONS AND WARRANTIES**

The Developer represents and warrants to the RDN as follows, with the intent that the RDN shall rely on the representations and warranties in entering into this Agreement and in concluding the purchase and sale contemplated by this Agreement:

- a) The Developer is a corporation duly incorporated, validly existing and in good standing under the laws of British Columbia, and has the power and capacity to own and dispose of the Works and to enter into this Agreement and carry out its terms to the full extent;
- b) The execution and delivery of this Agreement and the completion of the transaction contemplated by this Agreement has been duly and validly authorized by all necessary corporate action on the part of The Developer, and this agreement constitutes a legal, valid and binding obligation of The Developer enforceable against The Developer in accordance with its terms;
- c) Neither the execution and delivery of this Agreement, nor the completion of the purchase and sale contemplated by this Agreement will give any person the right to terminate, cancel or remove the Works, or any part thereof;
- d) The Developer owns and possesses and has a good marketable title to the Works free and clear of all mortgages, liens, charges, pledges, security interests, encumbrances or other claims;
- e) The Developer has no indebtedness to any person, firm or corporation which might by operation of law or otherwise now or hereafter constitute a lien, charge or encumbrance upon any of the Works;
- f) There is no litigation or administrative or governmental proceeding or inquiry pending or to the knowledge of The Developer threatened against the Water/Sewer/Streetlighting System, or the Works or any part thereof, nor does the Developer know of or have reasonable grounds that there is any basis for such action, proceeding or inquiry.

Initial	Initial
---------	---------

- g) All governmental licenses, permits and certificates required for the construction of the Works have been obtained and are in good standing and The Developer is not in breach of any statute, bylaw, regulation, covenant, restriction, plan or permit;
- h) The Works are in good working order and are fit for the purposes intended, in particular, for the operation of a water and sewer system by the RDN. A copy of the "Certification of Installed Works" by (name of the Engineers) employed by the Developer is attached hereto as Appendix "B".

5. **INDEMNITY**

The Developer covenants to save harmless and indemnify the RDN from and against:

- a) Any indebtedness or liability to any person, firm or corporation which might by operation of law or otherwise now or hereafter constitute a lien, charge, mortgage, security interest or encumbrance upon any of the Works, save and except any such indebtedness or liability created or caused by the RDN; and
- b) Any and all actions, suits, proceedings, demands, assessments, judgments, costs and legal and other expenses arising out of or from the construction and ownership of the Water/Sewer/Streetlighting System by the Developer.

6. **SURVIVAL OF WARRANTIES**

All representations, warranties, covenants and agreements made by the Developer in this Agreement or under this Agreement shall, unless otherwise expressly stated, survive closing and any investigation at any time made by or on behalf of the RDN shall continue in full force and effect for the benefit of the RDN.

7. **FURTHER ASSURANCES**

The parties shall execute such further and other documents and do such further and other things as may be necessary to carry out and give effect to the intent of this Agreement.

8. **TERMINOLOGY**

Wherever the singular or the masculine are used in this Agreement, they shall be construed as meaning the plural or the feminine or body corporate or politic where the context of the parties require.

9. **BINDING EFFECT**

This Agreement shall enure to the benefit of and be binding on the parties hereto and their respective successors and permitted assigns.

10. **HEADINGS**

The headings in this Agreement are inserted for convenience only and shall not be construed as part of this Agreement for the purpose of interpretation.

IN WITNESS WHEREOF the parties hereto have executed this Agreement at the Regional District of Nanaimo, Province of British Columbia, the ____ day of the _____, 20__.

Initial	Initial
---------	---------

Executed by the)
REGIONAL DISTRICT OF NANAIMO)
this ____ day of _____, 20____)
by its authorized signatories:)

_____)
Carol Mason, Chief Administrative Officer)
)
)
)

_____)
Maureen Pearse, Senior Manager)
Corporate Administration)

Executed by The Developer)
this ____ day of _____, 20____)
by its authorized signatories:)

_____)
)
)
)
)
)

Initial	Initial
---------	---------

Appendix 'A'
SYSTEM OF WORKS

Initial	Initial
---------	---------

Appendix 'B'

CERTIFICATION OF INSTALLED WORKS

Initial	Initial
---------	---------

**REGIONAL DISTRICT OF NANAIMO
BYLAW NO. 500**

SCHEDULE '7D'

COMMUNITY WATER SYSTEM STANDARDS

APPENDIX 10

MAINTENANCE AGREEMENT